

MOM - DUCT SYSTEM/ACCESSORIES

94007EN-21
2023-01

Installation instructions

Ventilation system with heat recovery

Knowledge of the correct installation method
is important for:

- Avoiding errors and complaints
- Ensuring a satisfied customer

Correct installation = Your responsibility



**Read the installation
instructions BEFORE
installing the ventilation
system with heat recovery**

Contents

1. System.....	3
1.1. Schematic diagram - ducting.....	3
1.2. Component location.....	4
1.3. Planning and preparation work	5
2. The four installation phases:.....	6
2.1. Main installation	6
2.2. Sealing sleeves, wind and humidity barriers.....	6
2.3. Final installation and initial adjustment.....	6
2.4. Handover	6
3. Duct installation	7
3.1. General.....	7
3.1.1. Execution.....	7
3.1.2. Clean building process	8
4. Mounting of flexible aluminium ducts	9
4.1. Round steel ducts (spiral)	10
4.2. Wall duct (telescopic).....	10
4.3. Steel duct (telescopic).....	10
4.4. Fire dampers	10
4.5. Iris dampers	10
5. Installation of cellular rubber insulated steel duct.....	11
5.1. Cutting insulated steel ducts.....	12
5.2. Joining cellular rubber insulated steel duct to cellular rubber insulated steel duct	12
5.3. Joining of cellular rubber insulated steel duct to uninsulated duct with an insulation sleeve	13
5.4. Joining of cellular rubber insulated steel duct to silencer	14
5.5. Accessories.....	14
6. General on ducts.....	15
6.1. Joining.....	15
6.2. Suspension points	16
6.2.1. Suspension of insulated ducts.....	16
6.3. Insulation	17
6.4. Accessories	19
7. EcoNordic	20
8. Exhaust air details - intake.....	21
8.1. Roof cowl	21
8.2. Wall hood.....	21
8.3. Fresh air intake	22
9. Valves.....	22
9.1. Position	22
9.2. Installation.....	23
9.3. Adjustments	23
10. Maintenance MOM.....	23
11. Initial adjustment record	24

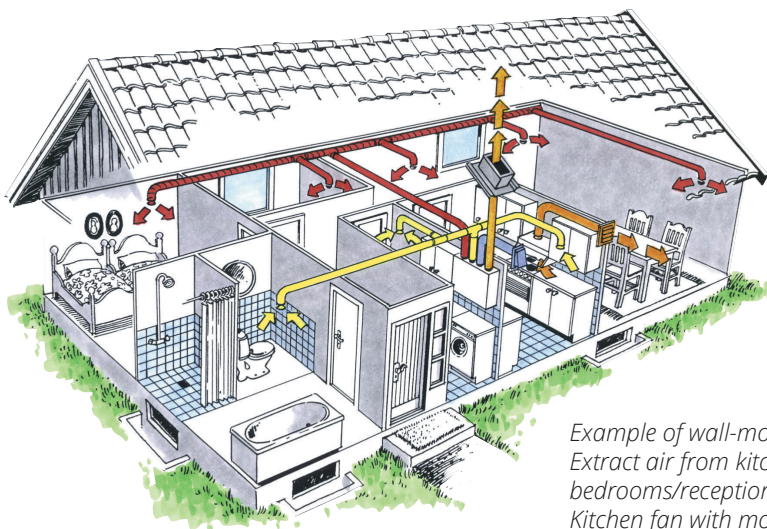

 All electrical connections must be carried out by qualified electricians.

*Example of wall-mounted air handling unit:
Extract air from kitchen and two wet rooms, supply air to four bedrooms/reception rooms
Kitchen fan with motor - separate*

1. System

1.1. Schematic diagram - ducting

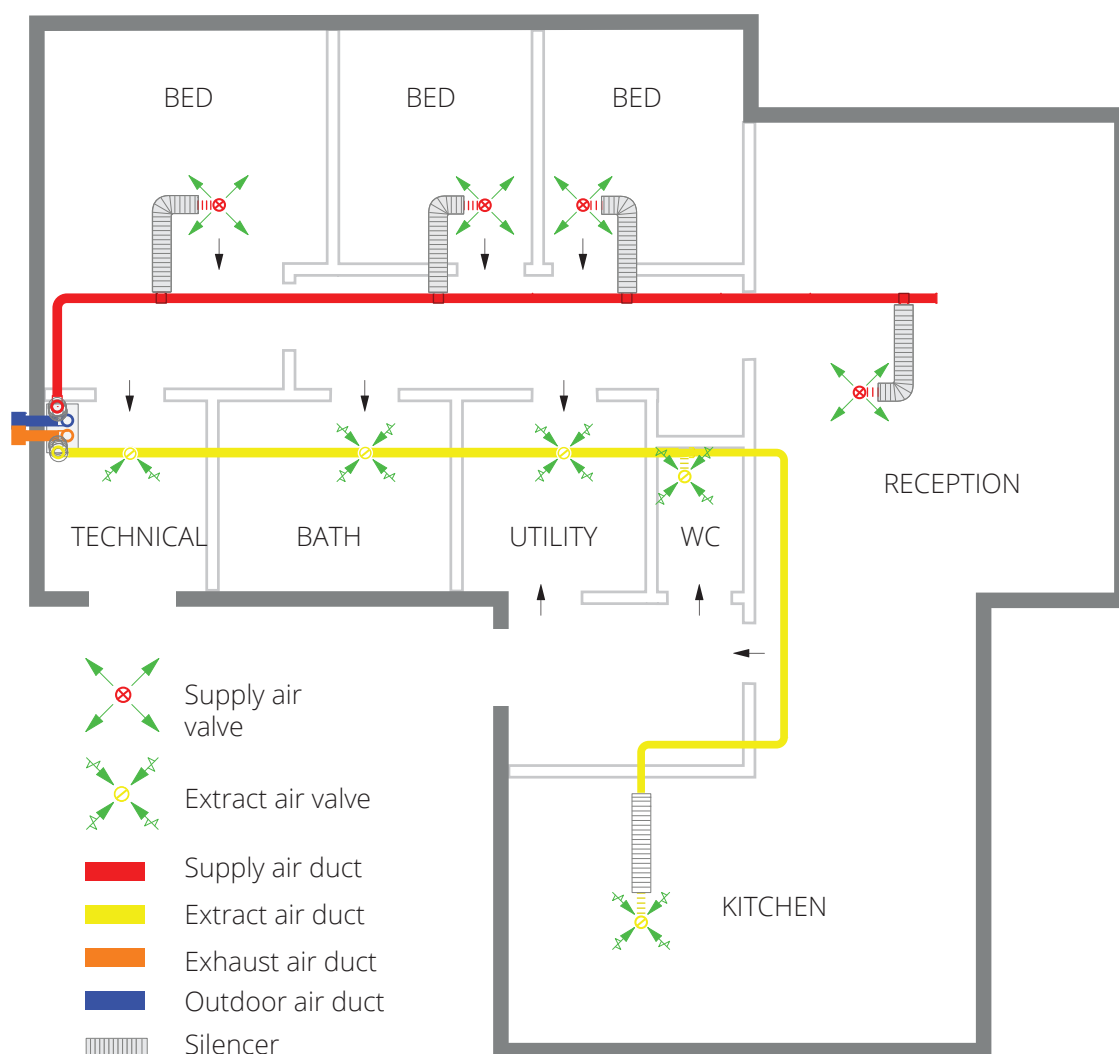

1.2. Component location

Follow the installation drawings. Use the correct parts/components in accordance with drawings. Also important to employ the correct dimensions.

Read the information on the ventilation drawings.



Remember flush threshold doors or gaps in door frames (min. 10-20 mm), to allow fresh air to pass freely from bedrooms to wet rooms. Alternatively, overflow valves can be fitted in doors or walls to allow air to pass between two rooms (2.2 cm² opening per m³/h air) (Ref. NBI design sheet A527.204).



To ensure the system provides the project design values, it must be measured and adjusted after installation is complete.

This list is advisory.

Component/activity	Time/date	To be carried out by
Roof cowl	At the time of roof-laying	The roofer
Outdoor air intake	After the external walls are in position	The ventilation installer
Main ducts	Prior to insulation of building	The ventilation installer
Branch ducts to valve points	Prior to insulation of storey partition	The ventilation installer
Sealing sleeves	Once the humidity and wind barrier is installed	The ventilation installer
Ventilation unit	When the walls/floor are complete	The ventilation installer
Control power to ventilation unit	Conduit before walls are sealed	Electrician
Main power supply to ventilation unit	At the same time as other electrical points	Electrician
Installation of valves	Once the building has been cleaned	The ventilation installer
Initial adjustment of valves	Once the building has been cleaned	The ventilation installer
Adjusting the ventilation unit	Once the ventilation unit has been installed	The ventilation installer
Handover to user	When the system has been checked and is ready for operation	Construction manager/installer
End caps	After the valve bracket has been mounted	The ventilation installer

1.3. Planning and preparation work

Important information!

1. JOINER - FITTER

- **Overflow between rooms.** Implemented with a gap under doors of 20 mm up to 72 m³/h or an overflow opening of 2.2 cm³ per m³air per hour. Table 624 in construction detail sheet 552 303 (Balanced ventilation in small houses) gives the recommended dimensions for overflow openings in dwellings.
- **Kitchen.** If the kitchen fan is designed with a motor, supply air must be provided to ensure negative pressure. The UNI range and later models allow this to a certain extent via the ventilation system, e.g. with a pressure relay which changes the unit speed when the kitchen fan starts up. Alternatively, a window or similar can be used. Kitchen fans with extra high capacity will require additional measures to ensure air supply.
- **Fireplace.** Airflow to fireplace of 150-300 m³/h should be in the form of a fresh air duct directly to the fireplace (described in NBI Construction Detail Sheet A 552 135) or use a ventilated pipe.
- **Location of air handling unit.** Location of the unit on an internal wall requires sound insulation of the wall, interrupted studs and boards, and double plasterboard or a wall structure of similar quality. See Byggforsk Construction Detail Sheet 524.325 (Sound insulation properties for lightweight internal walls.) If located on external walls, interrupted boards against adjacent rooms are recommended.
Cabinet units in wet rooms must be located outside zone 2 (minimum 0.6 m from the edge of the bath and 1.2 m from the shower head).
- **Hanging** a cabinet unit An adequate transom of min. 48x98 mm between studs is required for the bracket screws. For dimensions, see the installation instructions on www.flexit.com
- **Access.** The unit must have good access for service/maintenance. This applies especially in front of the door. See installation instructions for the unit.
- **Fire requirements.** Any fire safety requirements must be clarified.

2. ELECTRICIAN

- **Power supply.** The units have an approx. 2 m cable with plug and require a single-phase earth point close by. Domestic units require 10A, check specifications on website. **NB It is important for the plug/switch to be accessible for servicing when the unit is fully installed.** We recommend a separate circuit and an earth fault breaker for the unit. For permanent installation, it is possible to use a fuse in the installation network, provided that it is approved and it must be possible to secure it in the off position. Or a separate approved service switch can be installed.
If a separate kitchen fan is used, it must have its own socket (10A) in the area above the cabinet. A signal cable to a pressure relay or a kitchen fan connected to the unit should be run in min. Ø 16 mm conduit from the unit.
- **Wiring for control switch and cabled accessories** Ø 20 mm conduit for running the control cable for controlling the unit to be laid between the unit and an easily accessible place in the home (e.g. outside the bathroom) and terminated with a control point, see instructions for the specific control system. The control cable must be located min. 30 cm away from any power cables. The control cable must be max. 24 m long to ensure a signal.
Lay a Ø 16 mm conduit between the unit and the location of the accessory in question (kitchen fan, pressure relay, humidity sensor, etc.).
- **Conduit for intake solution.** A Ø 16 mm conduit should be laid to the air intake for providing protection (heating cable) against icing in the winter.

Nordic and EcoNordic ranges: Ø 20 mm conduit for running network cable between unit and router.

NB: Each product's installation instructions must be followed.

2. The four installation phases:

2.1. Main installation

Done before insulating the building. Mount the ducting/silencers according to the drawing up to the valve brackets. Remember to blank off the valve brackets (red plastic caps). Any other open ducts must be blanked off.

CLEAN BUILDING! Insulate ducts according to drawings and installation instructions. Remember importance of correct insulation. Avoid cold bridging in order to prevent risk of condensation and heat loss.



A poorly installed/insulated/taped outdoor air/exhaust air duct is the commonest reason for condensation problems and thus complaints.

2.2. Sealing sleeves, wind and humidity barriers

Done when the wind and humidity barrier is in place/has been installed by carpenter. The fitter must ensure the sealing of his/her own work where openings penetrate the wind or humidity barrier. Our sealing sleeves come with separate instructions.

2.3. Final installation and initial adjustment

Not to be carried out until after completion of building. Carry out installation of the unit (separate installation instructions accompany the unit), remaining ductwork and connections (to unit, intake/roof cowl, wall hood).

Install valves and perform initial adjustment (see drawing). To ensure correct initial adjustment, airflow measuring equipment should be used. Initial adjustment of the air handling unit is done from the control panel. See instructions supplied with the control panel. Initial adjustment is performed on the Normal stage. See percentage value on ventilation drawing. Remember to make a correct percentage adjustment to both the supply air and the extract air fan, and the correct rotation of the valves according to the drawings.

2.4. Handover

Handover to end user occurs immediately before occupation. Must be clarified whether the fitter or construction manager is to perform the handover. Complete the form "Registration form for handover to user" and return to Flexit. It is recommended to make several copies (for client, developer, person making the handover). Important to agree on the filter subscription!

3. Duct installation

3.1. General

- Flexible ducts are normally used as adapter ducts from the unit (silencers) and as terminations ahead of valves (valve bracket with aluminium duct or silencer).
- Steel duct is normally used for the rest of the duct system.

3.1.1. Execution

Uninsulated ducting

- Used internally in buildings for supply and extract air where the surrounding areas maintain the room temperature or where the surrounding areas are already sufficiently insulated. I.e. on the “warm” side.

Insulated ducting

- Used where ducts pass through cold surrounding areas and where condensation can form.
- Used where ducts convey cold air through warm surrounding areas. Condensation barriers must be sealed along the entire duct run – and up to terminal connections. Otherwise, condensation will be able to form in the insulation.
- Special non-inflammable insulation is to be used in areas which require this.
- Remember to apply insulation all the way up to the unit (with strips) and round the joints and other fittings.
- NB: Poorly insulated ducts can cause condensation/leakage problems and heat loss.
- The insulation joint in the sleeve should be laid downwards and in the inner radius in bend fittings.
- **Ducts for outdoor air and exhaust air MUST be insulated with 50 mm insulation OVER THEIR WHOLE LENGTH from the unit up to the outer wall/roof penetration! This regardless of whether they pass through a cold or warm zone.**

For space reasons, UNI2 and K2 may be insulated with a 25 mm insulation sleeve between the unit and the ceiling, after which the the ducts are to be insulated with 50 mm insulation sleeve.

If condensation insulation alone is sufficient and the duct is free-hanging, cellular rubber insulated duct details are a good choice.

Silencers

- Used where duct noise and unit noise needs to be attenuated, e.g. supply air to bedrooms and receptions rooms and extract valves from a kitchen.
- Normally to be located ahead of a valve. The silencer should be laid in a curve for optimum attenuation. It is important to pull the silencer all the way out!
- Silencers in cold zones must be insulated externally with an insulation sleeve (50 mm), or in some other way. Silencers are available in 0.75 m or 1.5 m.

The 0.75 m silencer must be mounted as close as possible to the valve for optimum attenuation (see also drawing). The silencer should be stretched to its full length for optimum silencing effect. When the silencer is mounted in cold surroundings as an extract air duct from rooms with high air humidity, the silencer must be provided with insulation. (Insulation is not included in standard delivery)

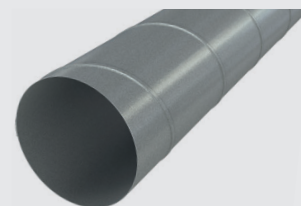

Steel duct



Uninsulated



Silencer (grey)



Insulated (white)

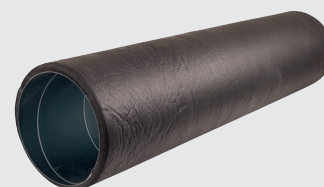

Cellular rubber insulated steel duct

3.1.2. Clean building process

It is a requirement of the building regulations that the ventilation unit is blanked off for dust during the construction process.

- This can be done in different ways, by means of end caps, dust caps or packaging.
- The ducts must be mounted so that they too can be subsequently cleaned.
- Where there is a requirement for extra clean air (respiratory problems), cleaning of the duct system should be considered before taking the system into use.

Prevention of condensation during building process

- It is very important to blank off the duct system during the construction period and to ensure the unit is blanked off (valves) until commissioning. This is to prevent the formation of condensation from unprocessed construction materials and water-based paints.

Inspection facilities/cleaning openings

The following locations can be used for this purpose:

- On the actual ventilation unit.
- The main duct, by removing the end cap.
- From the outdoor air intake/combibox.
- Branch ducts, by removing valves.

4. Mounting of flexible aluminium ducts

The ducts are supplied in compressed state and must be stretched before use.

If insulated ducts are not stretched to their full length, unneeded insulation/plastic sleeve should be cut off and removed.

These ducts are designed for adaptations/short distances. The normal standard is steel ducts.



NB! Straps at both ends of insulated ducts must be removed after stretching.

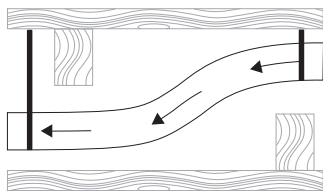

Gentle radius of curvatures result in lower air resistance and better ventilation and should be used.



Loads must not be applied to the pipes that can cause them to be crushed flat.

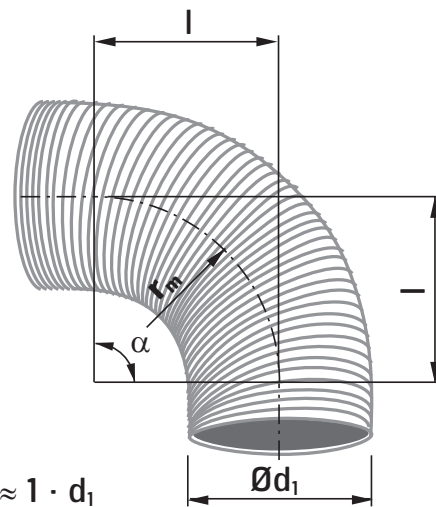

Avoid sharp changes of direction in flexible ducts/silencers. When mounting ducts, ensure that the bend radius is: $r_m \approx 1 \cdot d_1$

Silencer

Silencers must always be stretched to their full length for optimum silencing effect. Note that it will take some time for the air to fill the insulation material following compression, so try stretching it twice. Calculate the recess dimensions for uninsulated ducts, nominal diameter + 8 mm.



If the silencer is mounted in cold surroundings, it must be given additional external insulation.

Cutting of flexible ducts

If the duct needs to be cut, this is done by careful cutting with a Glava or Stanley knife.



Joining flexible ducts

- Make 3-4 longitudinal slits (approx. 3 cm) in the duct to make it easier to fit it onto the nipple.
- Tape the joint to seal it.
- Lock with self-tapping screws through the tape. Any gaskets on the nipple can be removed to ease threading the duct onto it.

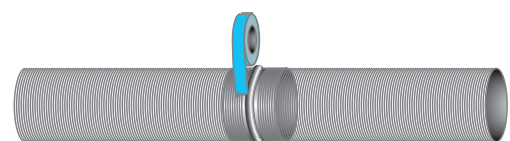

4.1. Round steel ducts (spiral)

- The ducts are supplied in 1.15 m lengths.
- The ducts must be provided with insulation on the construction site, if insulation is required.
- Use fittings for bends. Insulation joint in inner radius.
- Cut the ducts with a nibbler if possible, – cut along the flange. Tin snips (right and left hand model) can be used.

Do NOT use an angle grinder.

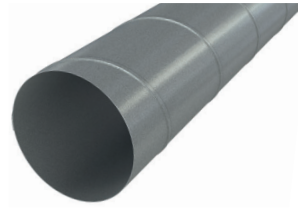

4.2. Wall duct (telescopic)

If this has been provided for, it is important to follow the instructions which accompany the wall ducts. See also the drawing for use of silencer.



4.3. Steel duct (telescopic)

The ducts are supplied in lengths of 30-55 cm and 60-115 cm and are used for adaptations.

The ducts must be provided with insulation on the construction site, if insulation is required.

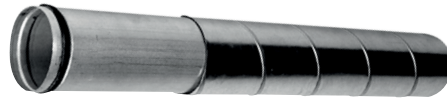

4.4. Fire dampers

Must have access for inspection and function testing (access via valve, T-piece or with telescopic duct).

With regard to mounting:

See instructions accompanying the product or www.flexit.com



4.5. Iris dampers

Iris dampers must have silencers fitted behind them to reduce noise. Access to the damper must be ensured (e.g. with a hatch) to allow for later adjustment.



5. Installation of cellular rubber insulated steel duct



NB! The insulation on duct components is only for condensation.



Problems which arise if condensation insulation is not carried out correctly:

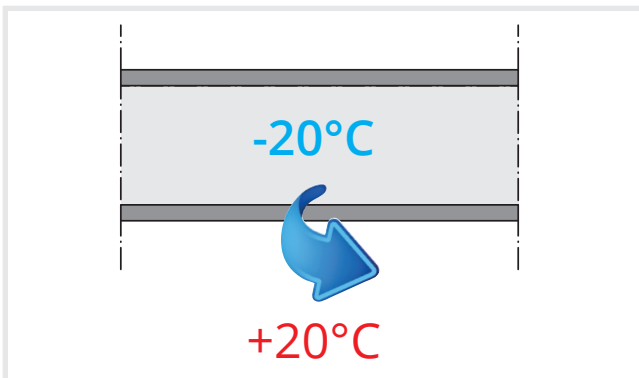

Warm room: Condensation on outside of ducts.



Problems which can arise if the components are used where heat insulation is necessary:

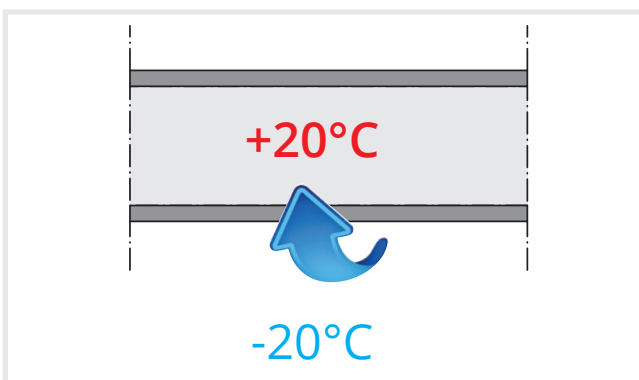

Cold room: The air in the duct cools down. Risk of condensation inside the duct.

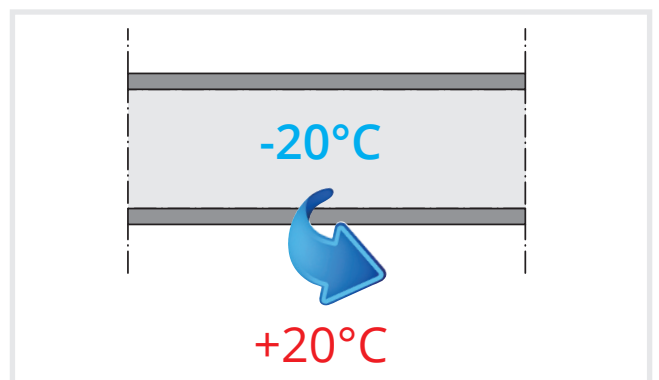

Warm room: The cold duct cools down the room.

5.1. Cutting insulated steel ducts

- Cut through the insulation all the way round the duct.
- Make sure that the insulation is cut right through.
- Make a hole in the steel duct using a knife or other suitable tool.
- Pull the insulation apart to make room for the snips.
- Cut the duct. When cutting, take care that the metal shavings do not damage the insulation.



5.2. Joining cellular rubber insulated steel duct to cellular rubber insulated steel duct

- Steel ducts are joined with joining nipples, bend fittings or T-pieces. Push the steel ducts over the nipple and gasket.
- All joints must be secured with at least three self-tapping screws. The insulation must be pulled aside to mount the screws. Screws and bits are supplied with the set.
- When the duct joints have been screwed, the insulation joints must be glued. This is done by applying contact adhesive all round the joint.
- After gluing, each joint must be taped all the way round with tape for cellular rubber ducts.
- When joining two components with a nipple end, a fixing sleeve must be used.

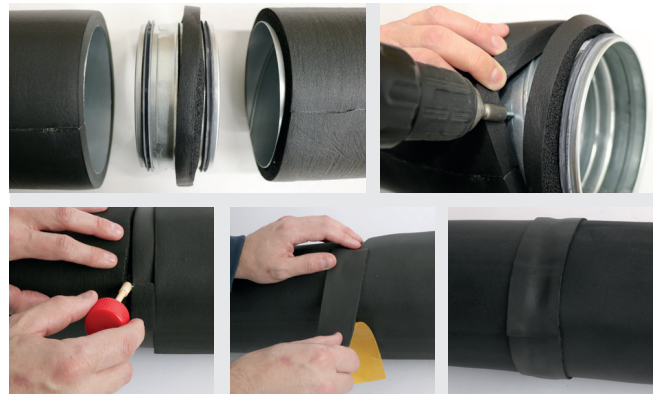

Fixing sleeve

Join steel duct with:



Bend fittings

Fixing nipple

T-piece

Humidity barrier

Where a cellular rubber insulated steel duct breaks a humidity barrier, it must be ensured that the penetration is fully sealed. Here special sealing sleeves are used in accordance with the accompanying instructions. An insulated duct cannot be lead directly through a humidity/wind barrier.

We recommend this is carried out as shown in the figure to ensure a tight seal is achieved.

- The cellular rubber insulated duct is led through the hole on the sealing sleeve.
- The sleeve must be one size larger than the steel duct. I.e. if you have a cellular rubber insulated steel duct of dimension \varnothing 160, then the sealing sleeve must be \varnothing 200.
- The outer part of the sleeve is taped against the plastic.

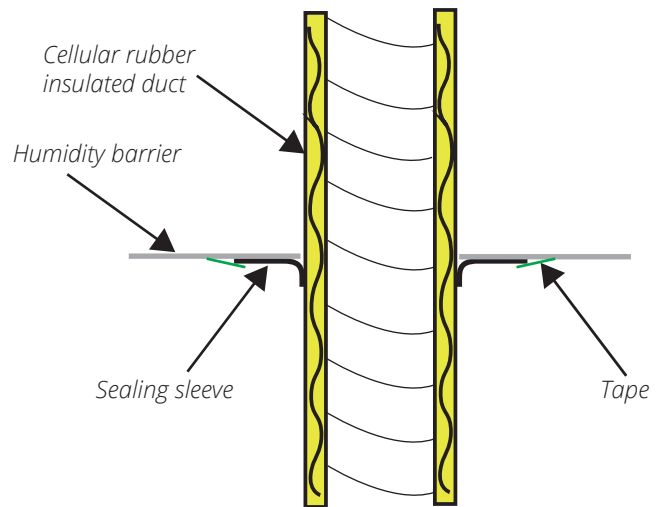

5.3. Joining of cellular rubber insulated steel duct to uninsulated duct with an insulation sleeve

- Ducts are joined by joining nipples, bend fittings or T-pieces. Push the ducts over the nipple and gasket.
- All joints must be secured with at least three self-tapping screws. The insulation is pulled aside when mounting the screws. Screws and bits are supplied with the set.
- Once the pipes have been screwed together, the plastic on the sleeve is pulled over the cellular rubber insulated duct by at least 5 cm and carefully taped all round.



For making joints to intake and exhaust: See Chap. 6.1.

5.4. Joining of cellular rubber insulated steel duct to silencer

- Ducts are joined by joining nipples, bend fittings or T-pieces. Push the ducts over the nipple and gasket.
- All joints must be secured with at least three self-tapping screws. The insulation is pulled aside when mounting the screws. Screws and bits are supplied with the set.
- Cut an approx. 30 cm section of an insulation sleeve (min. t=50mm) of the correct duct dimension.
- Push the insulation sleeve on to the end of the cellular rubber insulated steel duct and then screw it to the silencer.
- Screw the parts together.
- Push the insulation sleeve over the uninsulated part between the cellular rubber insulated steel duct and the silencer.
- Take care to tape the plastic on the sleeve all the way round, both against the cellular rubber insulated steel duct and the silencer.



Ensure that the joints are completely sealed. If air penetrates to the insulation, there is a risk of condensation forming, which could result in ice formation.

5.5. Accessories

Adhesive

for gluing joints on cellular rubber insulated duct components.
0.26 L with brush in stopper.



Tape

for taping over glued joints on cellular rubber insulated duct components.
Size 50 mm x 15 m



Sealing sleeves

Available in various sizes suitable for different penetration dimensions. For use where pipes break through humidity and wind barriers.

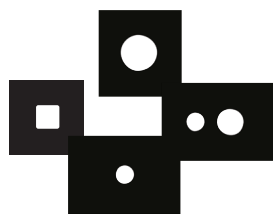

Tape

for sealing sleeves and insulation joints.
Size 60 mm x 25 m

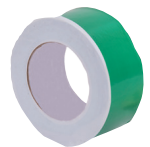

6. General on ducts

6.1. Joining

- Ducts are joined with joining nipples, bend fittings or T-pieces. Push the ducts over the nipple and gasket.
- All joints must be secured with at least three self-tapping screws. Screws and bits are supplied with the set.
- With insulated ducts, it must also be ensured that the joints are well insulated.
- Pull the plastic sleeves about 5 cm over each other and carefully tape together. Use non-elastic tape.
- NB: Taping must not flatten the insulation and reduce the insulation thickness.
- When joining two components with a nipple end, a fixing sleeve must be used.
- Intake/exhaust ducts must also be taped over the screw holes and joints prior to insulation in order to minimise the risk of leakage and condensation.

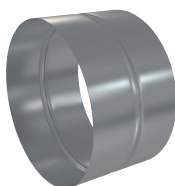

Fixing sleeve

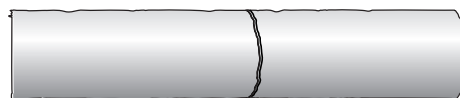
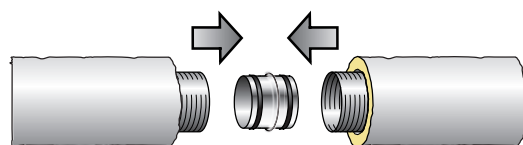

5 cm

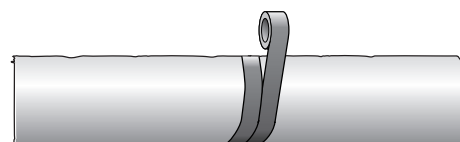

Join duct with:



Bend fittings



Joining nipple



T-piece

6.2. Suspension points

Intervals between suspension points should not normally exceed 2 m. Suspension points must ensure even loading of the ventilation system and must support and hold the system in place, avoiding displacement, vibration and deformation. Tip: Tie beams can be blocked up to the insulation level to prevent compression of insulation.

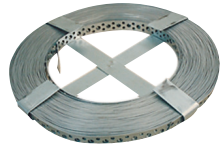

Perforated strip

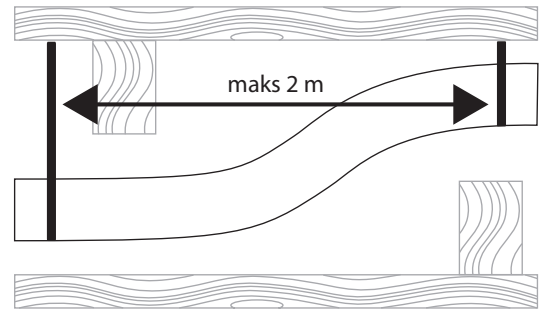

6.2.1. Suspension of insulated ducts

Suspension of free-hanging ducts

It is important that the suspension is carried out in a way which avoids compression of the insulation. Any "weak" points must be provided with additional insulation to prevent condensation.

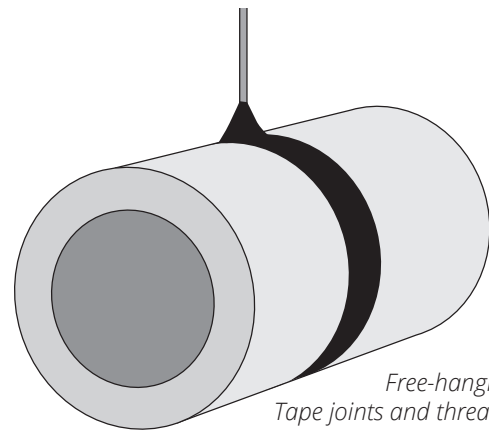

*Free-hanging duct.
Tape joints and threaded rod.*

Suspension of built-in ducts

Even where insulated ducts are built in, it is important to suspend the ducts in a way which prevents compression of the insulation. Where there is no access for duct hangers, perforated strip can be used, but it is important that all points which break the insulation are given additional insulation to prevent condensation.

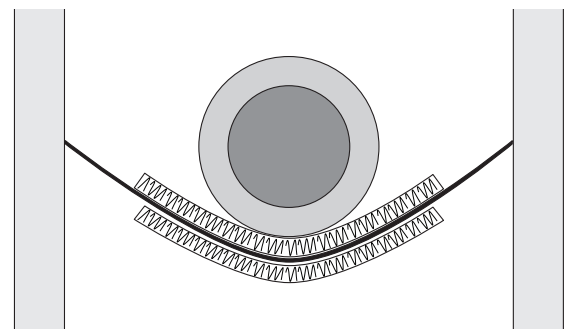

*Built-in duct.
Additional insulation of perforated strip with cellular rubber.*

6.3. Insulation

It is very important for function and energy savings (in case of heat recovery) that the insulation is carefully executed. It is important that the joint on the insulation mat stays on the inner radius at bends. It is also an advantage if this joint faces downwards when the duct is resting on the floor/insulation.

Supply air and extract air ducts in cold zones should have at least 100 mm insulation. Flexit supplies 50 mm as standard and the customer can select how to achieve the 100 mm.

The insulation may wholly or partly consist of roof beam insulation, insulation mats or loose-fill mineral wool. We recommend a 50 mm insulation sleeve + further roof beam insulation, insulation mat or loose-fill mineral wool, or 50 + 50 mm insulation sleeve.

Insulation of intake and exhaust

To prevent condensation, it is important that cold ducts are correctly insulated. The intake and exhaust **MUST** be insulated for condensation over their whole length. In the case of free-hanging ducts or suspension in uninsulated suspended floor spaces, 50 mm of insulation sleeve or cellular rubber can be used.

In floor spaces above rooms with high moisture production, apply Flexit 19mm cellular rubber +50mm insulation sleeve.

Condensation-insulated ducts must be free-hanging, and must not be additionally insulated outside the projected duct insulation.

Insulation sleeve

Only flexible ducts can be delivered ready-insulated from the factory, this does not include ducts pre-insulated with cellular rubber.. Steel duct must always be insulated on site. In addition all ducts which need over 50 mm insulation must be insulated on site. This can be done by threading an insulation sleeve over the duct or the existing 50 mm insulation. Position a reduction with plastic cap on the pipe end before threading the insulation sleeve over it. Keep the pipe steady and thread the sleeve over the whole pipe length.

In the case of two layers of insulation, it is important that the joint in the two insulation layers face in different directions.

Any fire insulation must always be executed on site. See the product instructions for installation.

Insulation up to silencer

Ensure that the insulation sleeve is pushed closely against the silencer and tape the joint well.

Silencers in cold zones must be insulated externally with an insulation sleeve (50 mm), or in some other way.



Outdoor air and exhaust air ducts must be insulated for condensation over their whole length with 50 mm insulation, and with the sleeve sealed at both ends.

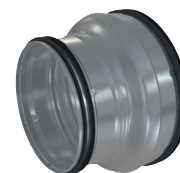

Reduction

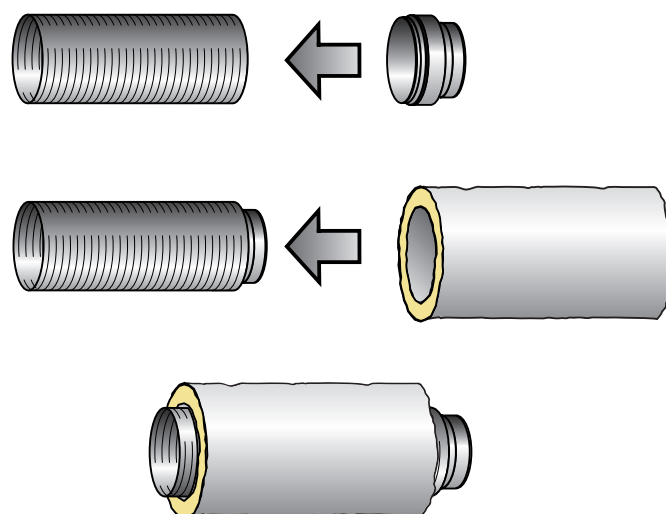

Insulation of steel duct

Sample pictures

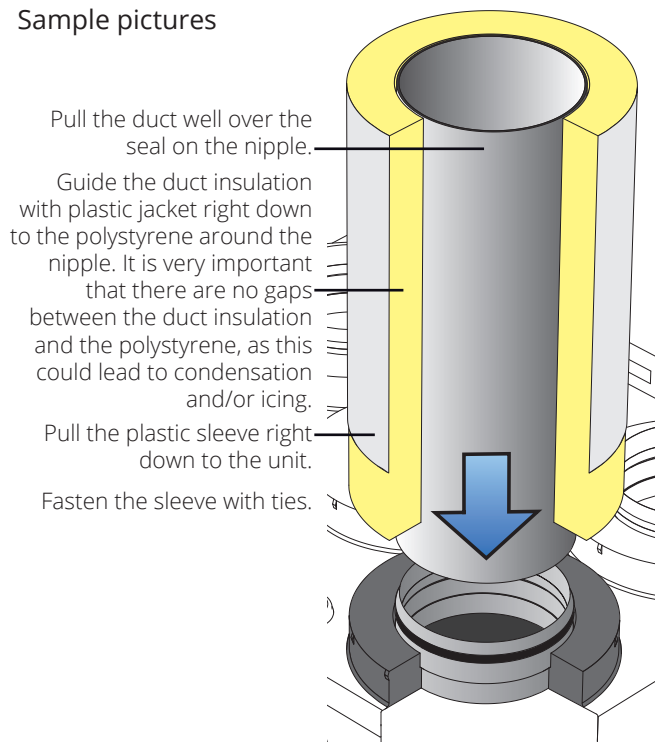

Pull the duct well over the seal on the nipple.

Guide the duct insulation with plastic jacket right down to the polystyrene around the nipple. It is very important that there are no gaps between the duct insulation and the polystyrene, as this could lead to condensation and/or icing.

Pull the plastic sleeve right down to the unit.

Fasten the sleeve with ties.

Duct connection



Fitted duct.

Insulation sleeve

Press the insulation sleeve on to the silencer and attach with tape to the plastic casing of the silencer. Then fit the silencer to the shoulder of the unit and screw firmly.

To screw, press the lower edge of the silencer up with a finger.

NB. Do NOT screw through the insulation sleeve!

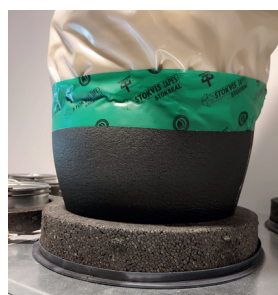

Insulation sleeve

Humidity barrier

Where an insulated duct penetrates the humidity barrier, it must be ensured that the connection to the barrier level is tightly sealed. For this, special sealing sleeves are used under separate instructions. An insulated duct cannot be led directly through a vapour/wind barrier. To ensure a seal, it is recommended to make joins as shown in the figure. Insulation sleeve against insulation ring. The plastic sleeve on the outside of the insulation ring is secured with strips/taped. On one side, the sealing sleeve is used, and this is taped to the plastic.

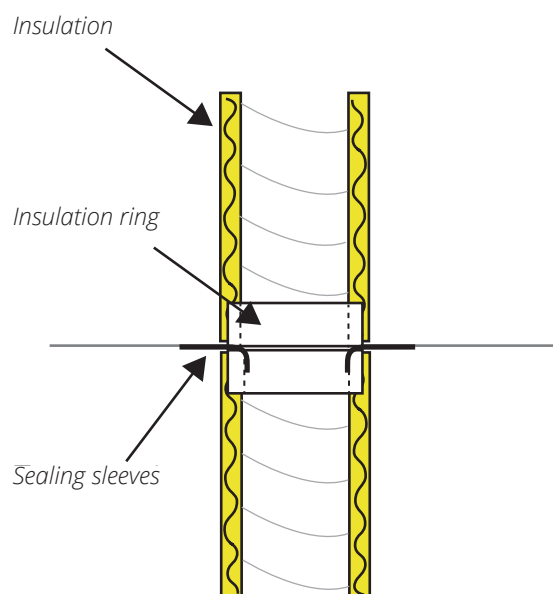

6.4. Accessories

End cap

Used at the termination of the main duct. Must also be insulated in cold surrounding areas. Can be used as an inspection/cleaning hatch.

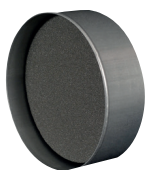

Valve bracket with Reduction 125/100

Used as termination of branch duct, where the airflow requires a valve of diameter Ø 125 mm. The branch duct will have a diameter of Ø 100 mm while the valve is Ø 125 mm.



Valve bracket with Silencer 125/100, length 1.2 m

Used to terminate branch duct in reception rooms where the airflow requires a valve of diameter Ø 125 mm. The branch duct and silencer will have a diameter of Ø 100 mm while the valve is Ø 125 mm. Used where there is plenty of space, e.g. unheated loft spaces. In storey partitions, space is limited, and the silencer and valve bracket with aluminium duct 125/100, length 0.6 m is recommended.



Valve bracket with aluminium duct 125/100, length 0.6 m

Used as termination of branch duct in wetrooms, where the airflow requires a valve of diameter Ø 125 mm. The branch duct will have a diameter of Ø 100 mm while the valve is Ø 125 mm.



Valve bracket with aluminium duct 100/100, length 0.6 m

Used to terminate branch ducts in wetrooms or in storey partitions (after silencer). The branch duct and valve have dimensions of Ø 100 mm.



Fire damper

Circular fire dampers which are held in open position by fusible links which melt at 72°C and two semi-circular butterfly closures. This prevents the spread of fire/combustion gases.

Available in Ø 100, Ø 125, Ø 160 and Ø 200.



Iris damper

Iris dampers must have silencers fitted behind them to reduce noise. Access to the damper must be ensured (e.g. with a hatch) to allow for later adjustment.



Sealing sleeves

Available in various sizes suitable for different penetration dimensions. For use where pipes break through humidity and wind barriers.

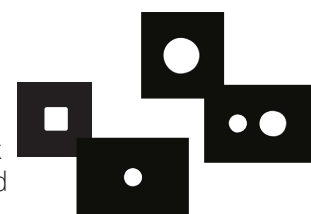

Insulation sleeve in foam rubber sleeve for condensation insulation between the unit sleeve coupling and flexible silencer. Insulation thickness 19 mm. Available in different sizes: Ø125 mm, Ø160 mm and Ø200 mm.



Tape

For sealing sleeves and insulation joints. Size 60 mm x 25 m

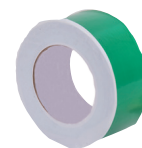

Tape

Tape for ducts insulated with cellular rubber. Size 50 mm x 15 m.



Insulation ring

for sealing sleeves Available in Ø 125, Ø 160 and Ø 200. See fig., page 18.



7. EcoNordic

Insulation

Above the unit, duct insulation may be carried out with 19mm cellular rubber, as space is so limited. Joints should be executed as previously described in this guidance.

Intake and exhaust

Two separate intake ducts must be installed for EcoNordic. One for ventilation and one for the heat pump. The exhaust from the ventilation and heat pump may be combined in a common exhaust duct.

Frost protection

To prevent cold convection currents in the heat pump in the event of power failure, a damper must be mounted in the heat pump duct. This is generally mounted directly over the heat pump in the exhaust duct. In particularly cold climates and where there is an integrated closing damper, the motor fixing on the closing damper should also be insulated.



Cellular rubber insulated steel ducts

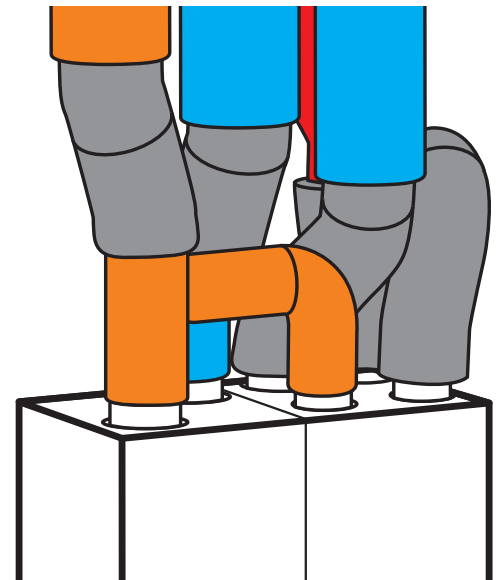

Pairing of exhaust air ducts

8. Exhaust air details - intake

8.1. Roof cowl

Available in the following main types:

- VS: For ventilation and soil pipe. Plastic cap must be removed before soil pipe is taken into use.
- V: A ventilation outlet.
- S: This is designed solely for connection to soil pipes. The roof cowl must be located as close over the unit as possible.

The roof cowls must be protected against snow slide by mounting snow catchers or other protection.



See separate mounting instructions available with the products or view them on www.flexit.com



8.2. Wall hood

This is a combined exhaust air and supply air box for facade mounting. Its special design avoid "short-circuiting" between the exhaust air and outdoor air. (Available in white or black).

Position

To be located the maximum distance away from sources of pollution such as traffic, chimneys, etc. If possible, should be mounted on the shadow side of the house and easily accessible for later cleaning. The ducts will preferably exit the house at the storey partition height. There must be 2-3 m clearance in front of the exhaust outlet. The box must not be positioned closer to the eaves than the corresponding width of the eaves, due to the risk of ice/condensation formation. Height over ground level should be min. 2 m.



See separate mounting instructions available with the products or view them on www.flexit.com



8.3. Fresh air intake

Position

As far as possible, all efforts should be made to achieve the following conditions. These are in order of priority, in the event that not all items can be easily satisfied.

1. The position must be as far as possible from sources of pollution, such as traffic, chimneys and other things which could pollute the outdoor air.
2. The position should be such that it is on the house's shadow side, so as to give cooler air in the summer.
3. The position should make it easy to access for later cleaning, as the intake may become blocked by leaves and other debris over time. Should be min. 2 m over ground level.

Models

The fresh air intake is available in the following variants, depending on duct dimensions on main ducts. See the complete range in our price list.



 See separate mounting instructions available with the products or view them on www.flexit.com

9. Valves

9.1. Position

Extract valves are mounted in kitchen, internal storerooms, WC and all wetrooms (bath, shower, utility and drying rooms). The valves are located in the ceiling or as high as possible on a wall, as close as possible to the place where water vapour/vitiated air occurs.

Supply air valves are located in bedrooms and reception rooms, normally in the ceiling, or else high up on the walls. Supply air valves may be fitted with blanking-off sector plates for preventing airflow in a desired direction.

If the supply air valve must or is desired to be located on a wall, a special valve with square front and round duct connection is used.

NB: Flexit steel valves do not match the valve bracket nipple with gasket.

See ventilation drawing design.



9.2. Installation

The valves are located in special pre-mounted valve brackets.

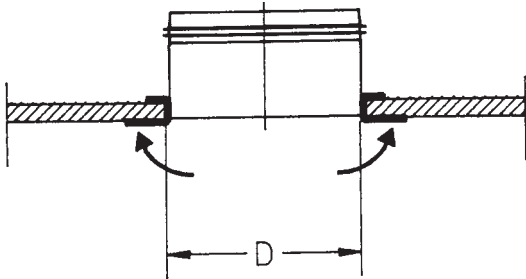

Aperture dimension D for valve brackets:

Duct dimension	D
100 mm	Ø 105 mm
125 mm	Ø 130 mm
160 mm	Ø 165 mm

After cutting out the hole, fit the valve bracket in the hole from the loft. Fold the three ears out across the ceiling to lock the bracket in place. Thread the duct onto the valve bracket. Block all duct openings with the attached plastic end caps or plastic caps during the construction period. When the ceilings (walls) are ready, press the valves into place on the valve brackets.

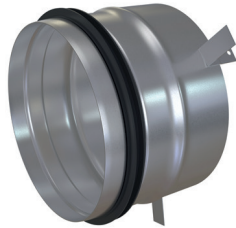

Valve bracket

9.3. Adjustments

The ventilation system is designed according to the relevant data and a theoretical pressure drop calculation is made. A capacity in [m³/h] is noted on the ventilation drawing for all valves, together with the adjustment as a number of turns from open to closed.

The supply air valve for walls with square front is adjusted by ensuring that the number of turns on the diagram is the same as the number of open rows of holes in the valve. Other rows are taped shut (tape included inside valve).

From this information, the valves in the system can be adjusted to ensure the capacity is as calculated.

Complete the form on the next page as documentation that this has been done. Adjustment of the air handling units is described in their installation instructions.

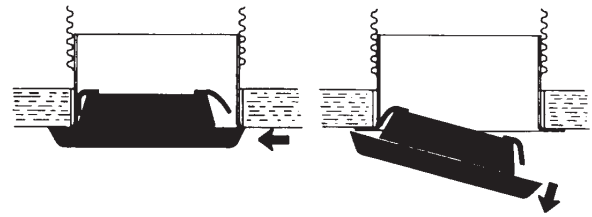

Once adjustments have been made, the valves are removed by pushing them to one side and then pulling them directly out of the valve frame (see sketch). Lock the valves in position with the locknut and replace.

10. Maintenance MOM

Technical details

Temperature internally in duct system	max. 90°C
Heat conductivity mineral wool λ10:	0.035 W/mK

The materials contain no allergenic substances.

Operation – maintenance

Aluminium ducts must not be exposed to chlorine-containing substances. Plastic sleeves (PE) over the insulation must not be exposed to sunlight.

Residential duct systems should be inspected internally min. every 6 years. Clean internally if necessary. Internal valves should be cleaned at least once a year with mild detergent.

Air intakes must be kept clear of leaves etc. In the winter in times of sea smoke, it may be necessary to scrape frost away.

Check roof cowls once a year to ensure that the drainage gap at the bottom is not clogged with leaves and debris.

Generally, an annual inspection is recommended to detect any damp problems from condensation in the system.



Flexit AS, Moseveien 8, N-1870 Ørje www.flexit.com