

CS2000 Automatic control V3

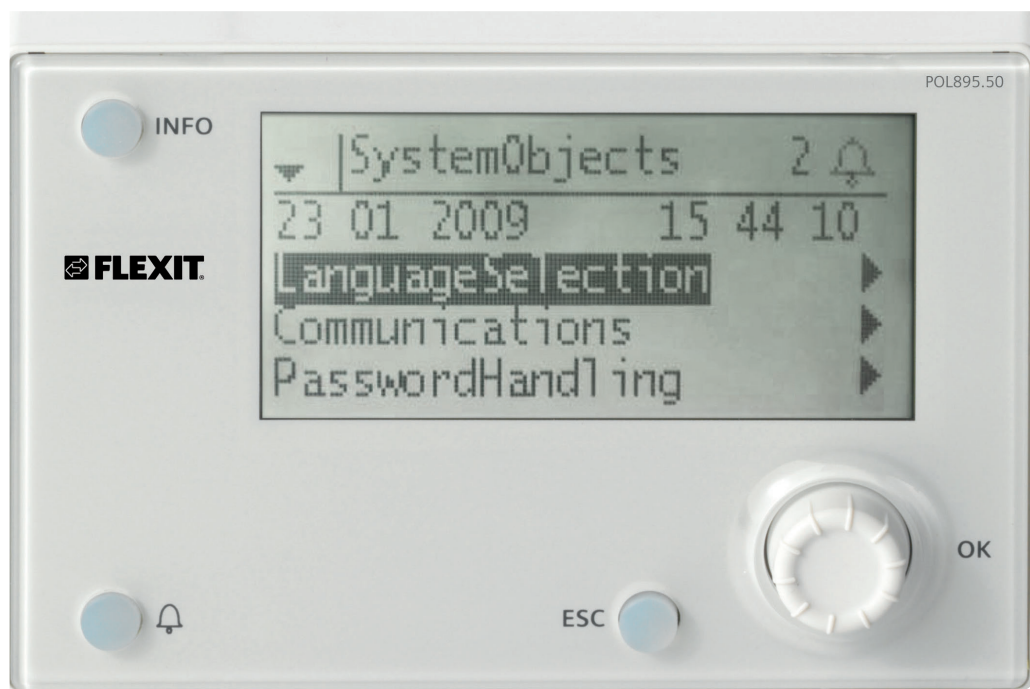



This user guide only applies to software version V3.x

To view current software version:

Start page > Main menu > System Overview > Versions > Flexit.ahu = V3.x

Contents

1.	Introduction	4
1.1.	Document description	4
1.2.	Highlighted boxes.....	4
1.3.	System overview	5
1.3.1.	System structure	5
1.3.2.	Ventilation unit's switching space	6
1.3.3.	Ventilation unit's control cabinet	7
2.	Getting started	9
2.1.	HMI	9
2.2.	Settings	9
2.2.1.	Introduction.....	9
2.2.2.	Select language	9
2.2.3.	Login	9
2.2.4.	Set time/time channels	10
2.3.	Adjust the setpoints for speeds and temperatures	12
2.4.	Service switch.....	12
2.5.	Extract air regulation.....	12
2.6.	Change the unit for the flow display	12
2.7.	Alarm handling	12
3.	Menu tree.....	13
4.	Backup and program updates	24
4.1.	Save a configuration.....	25
4.2.	Load a configuration	25
4.3.	Loan an application or software.....	25
4.4.	Error diagnosis - Snapshot	26
5.	General functions.....	26
6.	Configuration	27
6.1.	Configuration 1	27
6.2.	Configuration 2	32
6.3.	Configuration of inputs and outputs.....	36
7.	Cooling.....	37
7.1.	Installation	37
7.2.	Configuration - Cooling control.....	37
7.3.	For activation of circulation pump (only applies to liquid cooling)	37
7.4.	Blocking in connection with outdoor temperature	37
7.5.	Operating times (only applies to DX cooling).....	37
7.6.	Cooling restriction depending on fan speed (only applies to DX cooling)	38
7.7.	Setting of temperature setpoint	38
8.	Temperature regulation	38
8.1.	Extract air regulation.....	38
8.2.	To adjust supply air temperature limits with extract air regulation.....	38

9.	Summer/winter compensation	39
9.1.	Adjustment of fan setpoint in connection with high/low outdoor temperature.....	39
9.2.	Parameter settings for fan compensation.....	39
9.3.	Adjustment of temperature setpoint in connection with high/low outdoor temperature	39
9.4.	Parameter settings for temperature compensation.....	39
9.5.	Settings for switching between summer and winter operation	40
9.6.	Switch between summer and winter via signal	40
9.7.	Switch between summer and winter via date/outdoor temperature.....	41
9.8.	Temperature test for nighttime operation.....	41
9.9.	Nighttime cooling	42
9.10.	Support operation	42
9.10.1.	To activate the function	42
9.10.2.	To configure the function	42
10.	Fan regulation.....	43
10.1.	Select method of regulation.....	43
10.1.1.	Selection fan regulation method	43
10.2.	Pressure control.....	43
10.2.1.	Configuration of the pressure sensors' measuring ranges	43
10.2.2.	Pressure setpoint adjustment.	44
10.3.	External fan setpoint	44
10.3.1.	Parameter settings for Comp.....	45
10.3.2.	Parameter settings for Main.....	45
10.4.	External fan control via digital inputs	46
10.5.	Fire fan	46
11.	Connection of external equipment.....	47
11.1.	Fire damper	47
11.2.	Fire/smoke detector	50
11.3.	Air quality.....	51
11.4.	AUX Damper	52
12.	Web	53
13.	ModBus TCP/IP	54
14.	DX heating/cooling.....	54
14.1.	Configuration of control system	54
14.2.	Installation	57

1. Introduction

1.1. Document description

This document describes the main functions of the CS2000 automatic control and is divided into different sections for different parts of the system. If you only want to make basic settings to start the ventilation unit, there is a special section describing the startup procedure. If you require more detailed information, select the relevant section in the document.

 All electrical connections must be made by an expert.

1.2. Highlighted boxes

A number of different text boxes are used in the document to draw the user's attention to various things. This may be anything from pure information text to particularly important details to ensure that the system is not used incorrectly. Here is a brief description of the various boxes:

 **WARNING!** When a text is highlighted like this, it means that personal injury or serious damage to the equipment may result if the instructions are not followed.

 **NB** When a text is highlighted like this, it means that the equipment may be damaged or function poorly if the instructions are not followed.

 **RESTART**

> **EXAMPLE**
Italicised text boxes show examples

A table looks like this

with various values	with various values
with various values	with various values

1.3. System overview

1.3.1. System structure

The control system is divided into two subgroups:

1. One part that is located in the ventilation unit's switching space
2. One part that is located in a separate control cabinet on the outside of the ventilation unit

1.

Terminal blocks for incoming feed
Fuse for automatic control and fans (not electric heating coil)

Modbus extender - a communication card that connects the ventilation unit's components to the regulator via data communication

Power supply board - a circuit board that distributes the power supply to the ventilation unit's components and makes it possible to connect components to a water heating coil

2.

Regulator - the overall control system of the ventilation unit

Terminal board - a circuit board with terminal blocks for connection of additional components and accessories

HMI - the control panel used to communicate with the regulator

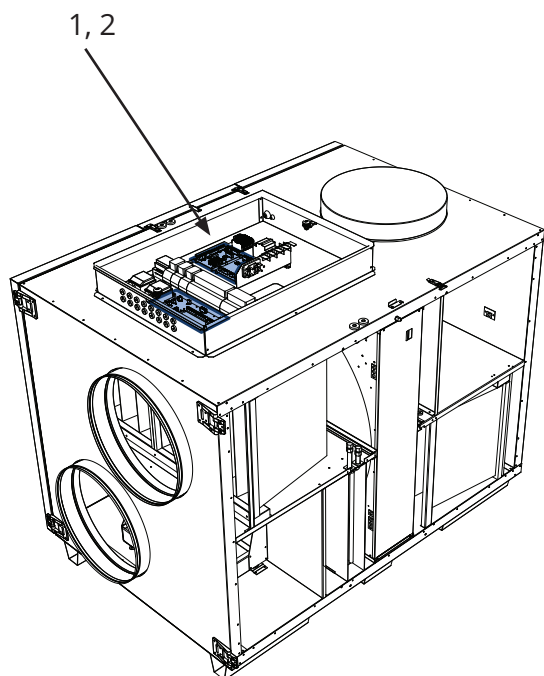
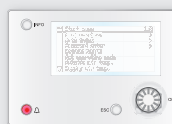

L model

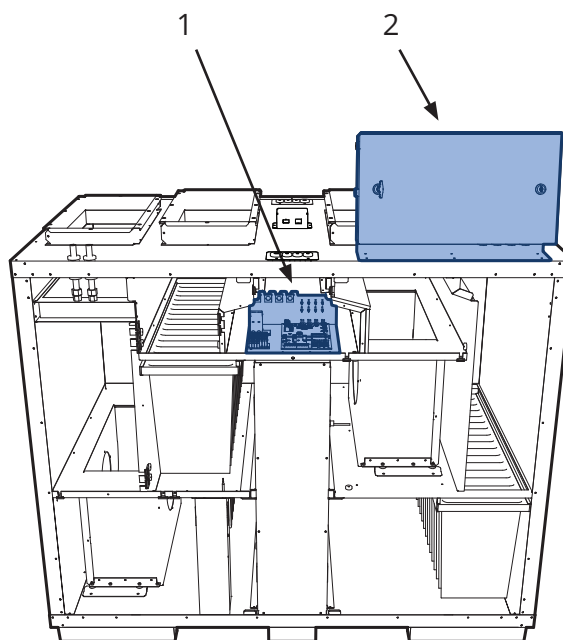

S model

1.3.2. Ventilation unit's switching space

Modbus extender

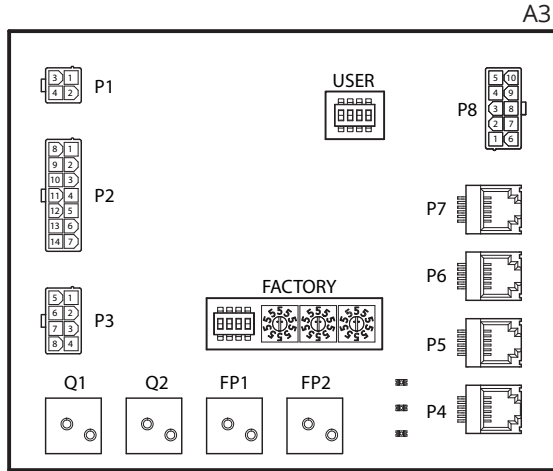

It is a communication card that connects the ventilation unit's components to the regulator.

The card has four dipswitches called 'USER' that are used to configure the unit, depending on the type of heating coil installed.

Dipswitch no.	ON	OFF
1	Heating coil	No heating coil
2	Electric heating coil	Water heating coil
3	-	Must be OFF
4	-	Must be OFF

The other four dipswitches and the rotary switches marked 'FACTORY' are factory-set and must not be changed.

The board's components have the following functions.

Component	Function
P1	Power supply
P2	Control signals to heating coil
P3	Control signals to rotor and temperature sensor
P4	Communication connection
P5	Communication connection
P6	Communication connection
P7	Communication connection
P8	Control signals to fans
Q1	Differential pressure monitor for flow measurement on supply air fan
Q2	Differential pressure monitor for flow measurement on extract air fan
FP1	Differential pressure monitor for supply air filter
FP2	Differential pressure monitor for extract air filter

Power supply board

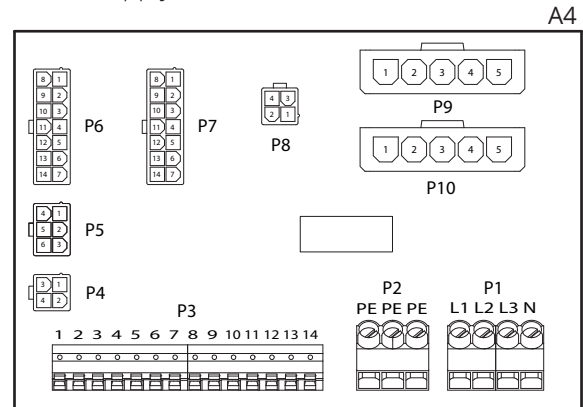

It is a circuit board that distributes the power supply to the components of the ventilation unit (not the electric heating coil) and control cabinet. There is also a terminal block for the components required to regulate a water heating coil.

The board's components have the following functions.

Component	Function
P1	Terminal block for power supply
P2	Terminal block for protective earth (PE)
P3	Terminal block for water heating coil
P4	Power supply to modbus extender
P5	Power supply to control cabinet
P6	Control signals to heating coil
P7	Control signals to heating coil
P8	Power supply to rotor control
P9	Power supply to supply air fan
P10	Power supply to extract air fan

Terminal block P3 has the following signals:

Block no.	Function
1	Valve motor - G0
2	Valve motor - 24 V+
3	Valve motor - G0
4	Valve motor - control signal 0-10 V
5	G0 (for F10 or B5)
6	Overheating thermostat F10
7	Return water sensor B5
8	No connection
9	N
10	Pump motor - relay contact
11	Pump motor - relay contact
12	L
13	N
14	L

1.3.3. Ventilation unit's control cabinet

Regulator

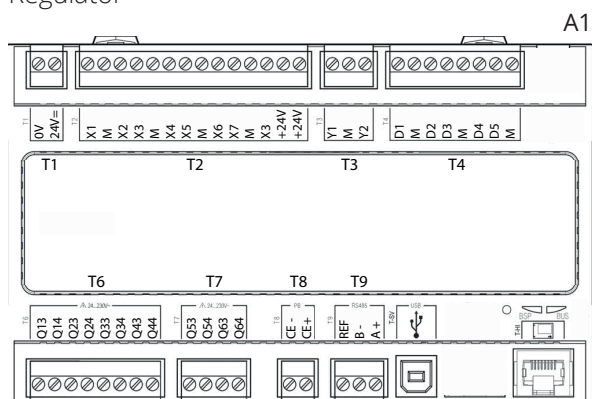

The ventilation unit's control system. This is where the control panel (HMI) and sensors and other components of the ventilation unit are connected. It is also possible to connect an SD memory card to back up or reload configuration settings and parameters for the regulator.

HMI

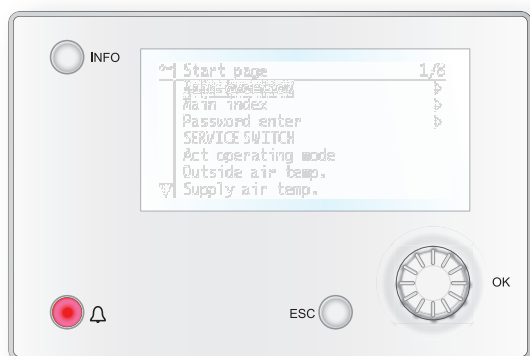

The control panel on which all settings and readings take place.

It has an 8-line graphic display and you navigate the menu tree using a dial that is turned. Selections are confirmed by pressing the same button.

Terminal board

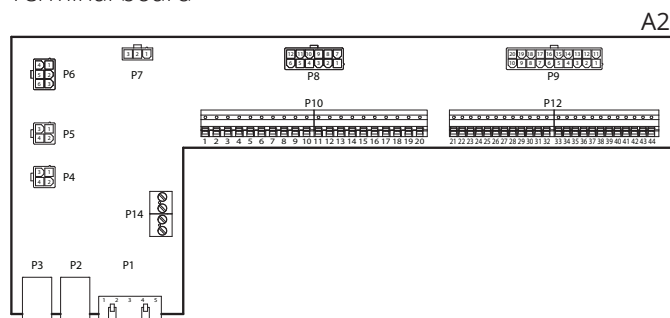

It is a circuit board that connects the components to the regulator. External components such as dampers are connected to this board via the terminal blocks on the board.

The board's components have the following functions.

Component	Function
P1	Connection for power supply
P2	Data communication
P3	Data communication
P4	Connection for external pressure sensor (accessory)
P5	Connection for external pressure sensor (accessory)
P6	Connection for 24 V transformer
P7	Data communication
P8	Connection for digital outputs
P9	Connection for control signals
P10	Terminal block for 230 V signals
P12	Terminal block for control signals
P14	Terminal block for protective earth (PE)

Terminal board

Terminal block P10 has the following signals:

Block no.	Function
1	L
2	N
3	L (Outdoor air damper)
4	L1 (Outdoor air damper ON/OFF)
5	N (Outdoor air damper)
6	L (Exhaust air damper)
7	L1 (Exhaust air damper ON/OFF)
8	N (Exhaust air damper)
9	L (Fire damper)
10	L1 (Fire damper ON/OFF)
11	N (Fire damper)
12	Buzzer alarm IN
13	Buzzer alarm OUT
14	DX cooling/cooling pump IN
15	DX cooling/cooling pump OUT
16	L
17	Heating IN
18	Heating OUT
19	N
20	Not used

Terminal block P12 has the following signals:

Block no.	Function
21	Cooling - 0-10 V [AO]
22	Cooling - G0
23	External control 1 [DI]
24	External control 1 - G0
25	External control 2 [DI]
26	External control 2 - G0
27	Fire/smoke [DI]
28	Fire/smoke - G0
29	Air quality - 0-10 [AI]
30	Air quality - G0
31	Heating - 0-10 V [AO]
32	Heating - 24 V+
33	Heating - G0
34	Fire damper open [DI]
35	Fire damper closed [DI]
36	Fire damper - G0
37	AUX damper - 0-10 V [AO]
38	AUX damper - G0
39	Return water sensor B5 [AI]/Overheating thermostat F20 [DI]
40	Return water sensor B5 [AI] - G0 / Overheating thermostat F20 [DI] - G0 External setpoint, supply air fan 0-10 V [AI] - G0
41	CE- [Data bus]
42	CE+ [Data bus]
43	External setpoint, supply air fan 0-10 V [AI]
44	External setpoint, extract air fan 0-10 V [AI]

2. Getting started

2.1. HMI

A central element in the system is the HMI (control panel), where you can adjust settings and take readings. The control panel consists of an 8-line graphic display, indicator lamps and controls for the settings. Here is a short introduction to the control panel showing how to enter the initial settings in the system.

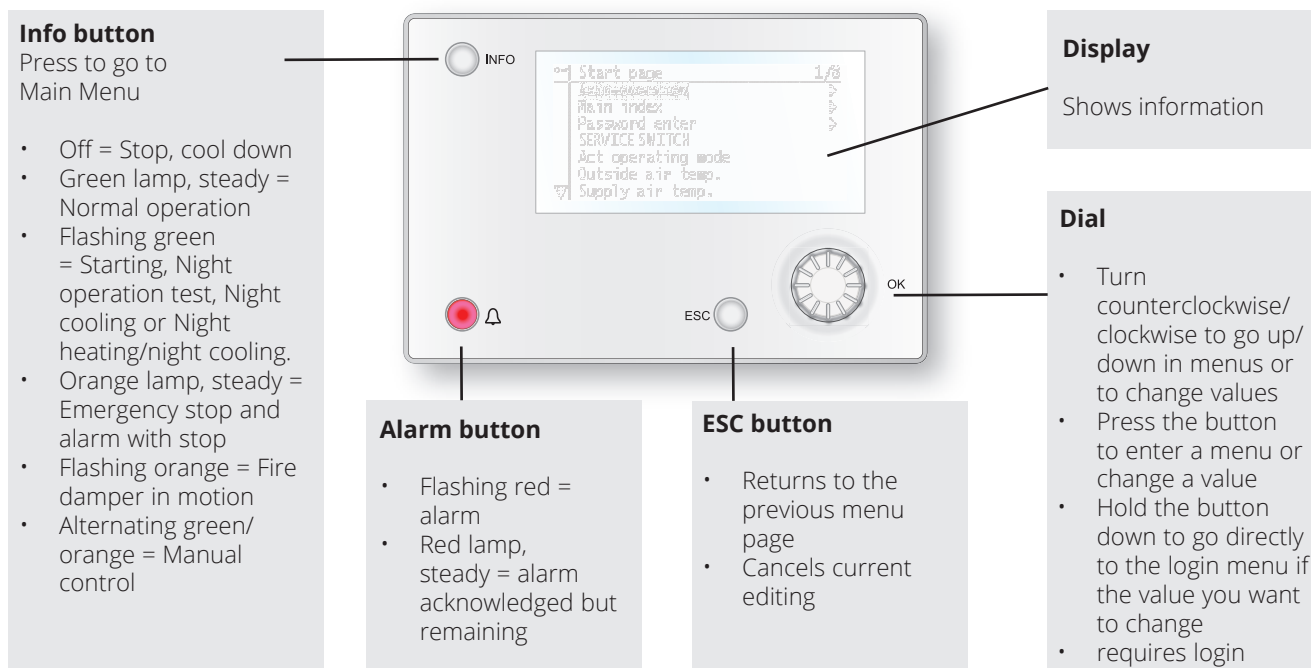

2.2. Settings

2.2.1. Introduction

The first time the system is started, you need to go through some simple steps to ensure that the system will function.

If a heating coil has been installed in the ventilation unit and the associated settings have been made with dipswitches in the switching space in the unit, the automatic control system will be restarted automatically once to complete the operation. No extra action needs to be taken. It is simply necessary to wait until the system has restarted.

There is a quick menu to access the most commonly used functions in the control panel, Language, Timing Program and Setpoint Settings.

2.2.2. Select language

To change the language on delivery:

Start page > Quick menu > Language selection > HMI Language > English

Changes the menu language to English.

2.2.3. Login

In order to make changes to the system, it is normally necessary to log in. There are four authority levels in the system, and three of them are password protected. The level at which the user is currently logged in is shown by the number of keys in the top left hand corner of the display. The menus show more options or fewer, depending on the level at which you are logged in.

The following actions are possible at the different levels:

Level 1: No restrictions, no password required.

- Read rights to all menus except system parameters, configuration and detail menus.
- Read rights to alarm lists and alarm history.

Level 2: End user, password 1000.

- All rights as for level 1, plus:
- Read rights to all menus except configuration menus.
- Write rights to the most important setpoints (Setpoints/Settings > Setpoints).
- Alarms and alarm history can be acknowledged and reset.

Level 3: System administrator, password 2000.

- All rights as for level 2, plus:
- Rights to all menus except I/O configuration and system settings.

Level 4: OEM, password given only in consultation with the Flexit service organisation.

- All rights as for level 3, plus:
- Rights to all menus and system settings.

Start page > Main menu > Log in

2.2.4. Set time/time channels

Start page > Quick menu > Timing program

Parameter	Function
Date and Time	This is where you set the time and date
Continuous operation	This is where you can override the timing programs and switch the unit to continuous operation
Current value	Displays the current timing (temperature and speed)
Monday to Sunday	See explanation of week schedule (2.2.4.2)

2.2.4.1. Set the calendar and timing program

General

This section describes functions and settings for the timing program and calendars.

When no object with higher priority (for example Manual control <> Auto) is activated, the system can be switched off or the steps changed via the timing program. A maximum of six switch-over times can be specified per day.

The calendar stop overrides the calendar exception, which in turn overrides the normal timing program (only in operating mode). Up to 10 periods or exception days can be specified for each calendar.

NB Both setpoints for fan steps and temperature setpoints (comfort /economy) are controlled by the timing program.

2.2.4.2. Week schedule

Parameter	Value	Function
Current value	---	Switching according to schedule
Monday		Shows current command when the current day is Monday. The latest time that can be entered for a day is 23:59. Go to the day switching schedule for Mondays
Copy schedule	-Mon to -Tu- Fr -Tu- Su	Copies times for the timing program from Monday to Tuesday-Friday/Tuesday-Sunday. - Passive (no copying). - Copying starts. Return to the display screen
Tuesday		Same function as for Monday
...		...
Sunday		Same function as for Monday
Exception		Shows current command when the current day is an exception day. Go to the day switching schedule for exception days
Period: Start Period: Start		(Only Authority level 3.) Start date for week schedule. *,* *.00 means that the week schedule is always activated. ---> Activate week schedule
Period: End Period: Start		(Only Authority level 3.) Start date and start time for deactivating week schedule

2.2.4.3. Dayschedule

Parameter	Value	Function
Current value	---	Switching according to the schedule when the current weekday is the same as the switching day
Day schedule	- Passive - Active	Status for current week or exception day: - Current weekday (system day) is not the same as the switching day. - Current weekday (system day) is the same as the switching day
Time-1		Special case: This time must not be changed, and must always be 00:00
Value-1		Switching command for Time-1
Time-2		Switching time 2 *: * ---> Time deactivated
Value-2 ... Value-6		Analogue value 1
Time-3 ... Time-6		Analogue time 2

2.2.4.4. Kalender (undantag och stopp)

Exception days can be defined in the calendar. These can include specific days, periods or weekdays. Exception days override the weekly schedule.

Calendar exceptions

Switching follows the weekly schedule and the exceptions specified in the day schedule when a switching time is activated in the calendar exception.

Calendar stop

The system is turned off when the calendar stop is activated.

Parameters:

Start page > Main Menu > Unit > Operating information > Timing program > Calendar exceptions

Start page > Main Menu > Unit > Operating information > Timing program > Calendar stops

Parameter	Value	Function
Current value	<ul style="list-style-type: none"> - Passive - Active 	Shows whether a calendar time is activated: <ul style="list-style-type: none"> - No calendar time activated - Calendar time activated
Val-x	<ul style="list-style-type: none"> - Date - Interval - Weekday - Passive 	Specification of exception type: <ul style="list-style-type: none"> - A certain day (e.g. Friday) - A period (e.g. holiday) - A certain weekday - Times are deactivated This value must always be placed last, after the date
-(Start)Date		<ul style="list-style-type: none"> - Val-x = interval: Enter the start date for the period - (Val-x = date: Enter specific date)
-End date		Val-x = interval: Enter the end date for the period The end date must be later than the start date
-Weekday		Val-x = only weekdays: Enter a weekday

EXAMPLE: Val-x = Date

Only the time for (start) is relevant.

- `-(Start)Date = *,01.01.16`

Result: 1 January 2016 is an exception date.

- `-(Start)Date = Mo,*.*.00`

Every Monday is an exception day

- `-(Start)Date = *,*.Even.00`

All days in even months (February, April, June, August, etc.) are exception days.

EXAMPLE: Val-1 = Interval

The times for (Start)Date and End date are adjusted.

- `-(Start)Date = *,23.06.16 / -End date = *,12.07.16.`

23 June 2016 until end of 12 July 2016 are exception days (for example holidays).

- `-(Start)Date = *,23.12.16 / -End date = *,31.12.16`

23-31 December are exception days every year. Time End date = *,01.01.16 will not work because 1 January comes before 23 December.

- `-(Start)Date = *,23.12.16 / -End date = *,01.01.17.`

23 December 2016 up to and including 1 January 2017 are exception days.

- `-(Start)Date = *,*.*.17 / -End date = *,*.*.17`

Warning! This means that the exception is always active! The system is constantly in exception mode or turned off.

EXAMPLE: Val-1 = Weekday

Val-1 = Weekday

The times for weekdays are adjusted.

- `Weekday = *,Fr,*`

Every Friday is an exception day.

- `Weekday = *,Fr,Even`

Every Friday in even months (February, April, June, August, etc.) is an exception day.

- `Weekday = *,*,*`

Warning! This means that the exception is always active! The system is constantly in exception mode or turned off.

2.3. Adjust the setpoints for speeds and temperatures

Start page > Quick menu > Setpoints/Settings

Parameter	Function
All settings	>
Timing program	>
Setp.comf.heat	Indicates the temperature setpoint
Setp.econ.heat	Indicates the temperature setpoint
Setp.TF step 1	Indicates the supply air flow
Setp.TF step 2	Indicates the supply air flow
Setp.TF step 3	Indicates the supply air flow
Setp.FF step 1	Indicates the extract air flow
Setp.FF step 2	Indicates the extract air flow
Setp.FF step 3	Indicates the extract air flow

2.4. Service switch

The service switch is used to stop the unit for service.

Start page > SERVICE SWITCH

Parameter	Function
Auto	The unit is controlled via time channel
Off	Service mode, unit stopped

2.5. Extract air regulation

The unit is configured by default to regulate temperature via the supply air. However, it can be reconfigured to regulate via the extract air. To do this, go to the following menu:

Start page > Main menu > Configuration > Configuration 1 > Temperature regulation type

Parameter	Function
Supply air	Temperature regulation is controlled by the supply air temperature
Extract air	Temperature regulation is controlled by the extract air temperature

After making a change in a configuration menu, a restart is required.

Start page > Main menu > Configuration > Configuration 1 > Restart > Execute



To adjust supply air temperature limits with extract air regulation.

Start page > Quick menu > Setpoints/Settings

Parameter	Function
Setpoint, min. supply air temp.	Indicates the lowest permitted supply air temperature
Setpoint, max. supply air temp.	Indicates the highest permitted supply air temperature

2.6. Change the unit for the flow display

Toggles between m³/h and l/s in the air flow rate display.

Start page > Main menu > Configuration > Configuration 2 > Flow display

Parameter	Function
No	Not used.
l/s	Displays flow in l/s
m ³ /h	Displays flow in m ³ /h

After making a change in a configuration menu, a restart is required.

Start page > Main menu > Configuration > Configuration 2 > Restart > Execute



2.7. Alarm handling

If an alarm has been triggered, it will be shown by the flashing alarm symbol. You can get more information by pressing the alarm button. To reset the alarm, press the alarm button twice and select Confirm/Reset and then Execute in the menu.

Alternatively, the alarm can be reset with the menu option:

Start page > Main menu > Alarm management > Alarm reset > Execute

3. Menu tree

Logging in gives you access to several menu options.

The menu tree reflects the default configuration. It may be different in other configurations.

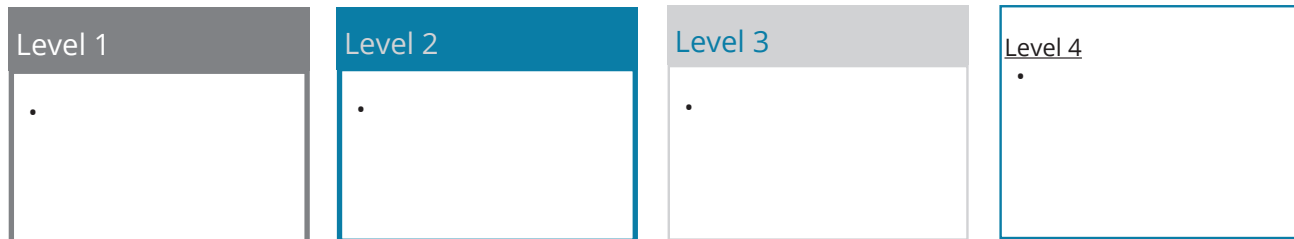

Start page

- Quick menu
- Main menu
- Operating information
- SERVICE SWITCH
- Operating mode
- Outdoor temperature
- Supply air temp.
- Extract air temp.



Quick menu

- Language selection
- Timing program
- Setpoints/Settings

Operating information

- Current operating mode
- - Alarm
- Timing program
- Outdoor temp.
- Extract air temp.
- Supply air temp.
- Outdoor air damper
- Exhaust air damper
- Current fan step
- Current setpoint SF
- Current actual value SF
- Supply air fan
- Supply air flow
- Current setpoint FF
- Current actual value EF
- Extract air fan
- Extract air flow
- Current actual value temperature
- Supply air
- Current setpoint heating
- Recovery

SERVICE SWITCH

- Auto/Off
- Save/Cancel

Main menu

- Log in
- Unit
- Communication
- General func.
- Alarm handling
- System overview
- Overview of IO config./raw values
- Configuration

Start page

Quick menu

- Language selection
- Timing program
- Setpoints/Settings

Language selection

- HMI language
+ Alarm snapshot
- Save -> SD
+ Modem
- SMS language

Timing program

- | Date | Time |
|------------------------|---------------|
| • Continuous operation | Current value |
| • Monday | |
| • Copy schedule | |
| • Tuesday | |
| • Wednesday | |
| • Thursday | |
| • Friday | |
| • Saturday | |
| • Sunday | |

Setpoints/Settings

- All settings
- Timing program
- Setp.comf.heat
- Setp.econ.heat
- Setp.TF step 1
- Setp.TF step 2
- Setp.TF step 3
- Setp.FF step 1
- Setp.FF step 2
- Setp.FF step 3

Start page



Main menu

- Log in
- Unit
- Communication
- General func.
- Alarm handling
- System overview
- Overview of IO config./raw values
- Configuration



Log in

- Password

Unit

- Operating information
- Inputs
- Outputs
- Operating functions
- Setpoints/Settings
- Damper control
- Fan control
- Temperature regulation
- Regulators
- Operating time

Communication

- Comm. modules
- Process bus
- TCP/IP
- Climatix IC
- Modbus
- Modem
- SMS
- Restart

General func.

- Summer/winter mode
- Manual operation
- Activate manual alarm
- Activate comm. test
- Communication test
- Set IO to
- Alarm Snapshot
- Snapshot memory full
- Trend archiving
- Trend archive export
- Trend archive full

Alarm handling

- Alarm reset
- Danger (A)
- High (A)
- Low (B)
- Warning (C)
- Alarm output selection
- Alarm output 1
- Modbus alarm
- Process bus comm.
- IO exp. bus
- Comm. module 1
 - Communication error
 - Status
- Comm. module 2
 - Communication error
 - Status
- Comm. module 3
 - Communication error
 - Status

System overview

- Date
- Time
- Communication
- Application info.
- Versions
- Save/Reset
- Diagnosis
- Trend archiving
- Alarm Snapshot
- Password administration
- HMI
- Language selection

Overview of IO config./raw values

- Temperatures
- Pressure/Flows
- Digital inputs
- Digital alarm
- Damper outputs
- Fan outputs
- Temp. control outputs
- Alarm outputs

Configuration

- Configuration 1
- Configuration 2
- Config. Inputs/Outputs
- IO config. control
 - Duplicated
 - Not configured
- Set IO to
- Overview, Outputs
- Inputs
- Integrations

Start page

Operating information

- Current operating mode
- - Alarm
- Timing program
- Outdoor temp.
- Extract air temp.
- Supply air temp.
- Outdoor air damper
- Exhaust air damper
- Current fan step
- Current setpoint SF
- Current actual value SF
- Supply air fan
- Supply air flow
- Current setpoint EF
- Current actual value EF
- Extract air fan
- Extract air flow
- Current actual value, temperature
- Supply air
- Current setpoint, heating
- Recovery

Current operating mode

- Auto/Off
- Save/Cancel

- Alarm

- Current
- Operating status
- SERVICE SWITCH
- Continuous operation
- Timing program
- From BMS
- External control
- Power up delay

Timing program

- Current value
- Monday
- Copy schedule
- Tuesday
- Wednesday
- Thursday
- Friday
- Saturday
- Sunday
- Calendar exception
- Exception
- Calendar stop

Outdoor temp.

- Supply air
- Outside
- Extract air

Extract air temp.

- Supply air
- Outside
- Extract air

Supply air temp.

- Supply air
- Outside
- Extract air

Outdoor air damper

- Outdoor air damper
- Exhaust air damper
- Open time

Exhaust air damper

- Outdoor air damper
- Exhaust air damper
- Open time

Current fan step

- Supply air fan
- Extract air fan
- Current fan step
- Block high speed
- Setting, operating time

Current setpoint SF

- Current fan step
- Current setpoint supply air
- Step 1
- Step 2
- Step 3
- Max. forced ventilation
- Min. operating time
- Power up delay
- Deviation alarm
- Ext. setpoint function SF

Current actual value SF

- Current value
- Regulator
- Output signal
- Operation
- Alarm
- Setpoints/Settings

Supply air fan

- Current value
- Regulator
- Output signal
- Operation
- Alarm
- Setpoints/Settings

Supply air flow

- Supply air flow
- Extract air flow
- Supply air filter
- Extract air filter

Current setpoint EF

- Current fan step
- Current setpoint extract air
- Step 1
- Step 2
- Step 3
- Max. forced ventilation
- Min. operating time
- Deviation alarm
- Ext. setpoint function EF

Start page

▶ Operating information, cont.



Current actual value EF

- Current value
- Regulator
- Output signal
- Operation
- Alarm
- Setpoints/Settings

Current setpoint, heating

- Current actual value temperature
- Supply air
- Current setpoint heating
- Comfort heating
- Economy heating

Extract air fan

- Current value
- Regulator
- Outdoor signal
- Operation
- Alarm
- Setpoints/Settings

Recovery

- Regulator
- Output signal
- Alarm
- Start time
- Start temp.

Extract air flow

- Supply air flow
- Extract air flow
- Supply air filter
- Extract air filter

Start page

Main menu

Unit

- Operating information
- Inputs
- Outputs
- Operating functions
- Setpoints/Settings
- Damper control
- Fan control
- Temperature regulation
- Regulators
- Operating time

Operating information

- Current operating mode
- - Alarm
- Timing program
- Outdoor temp.
- Extract air temp.
- Supply air temp.
- Outdoor air damper
- Exhaust air damper
- Current fan step
- Current setpoint SF
- Current actual value SF
- Supply air fan
- Supply air flow
- Current setpoint EF
- Current actual value EF
- Extract air fan
- Extract air flow
- Current actual value temperature
- Supply air
- Current setpoint heating
- Recovery

Outputs

- +Digital outputs
- Supply air fan
- Extract air fan
- Outdoor air damper
- Exhaust air damper
- Alarm output 1
- +Analogue outputs
- Supply air fan
- Extract air fan
- Recovery

Fan control

- Supply air fan
- Extract air fan
- Current fan step
- Block high speed
- Setting, operating time

Temperature regulation

- Current actual temperature value
- Temp. setpoints
- Heat recovery

Operating functions

- Current
- Operating status
- SERVICE SWITCH
- Continuous Operation
- Timing program
- From BMS
- External control
- Power up delay

Regulators

- Supply air fan
- Extract air fan
- Heat recovery

Inputs

- +Temperatures
- Extract air
- Supply air
- Outside
- +Pressure/Flows
- Supply air flow
- Extract air flow
- Supply air filter
- Extract air filter
- +Digital alarm
- Supply air fan
- Extract air fan
- Recovery alarm
- Digital inputs

Setpoints/Settings

- All settings
- Timing program
- Setp.comf.heat
- Setp.econ.heat
- Setpoint, SF step 1
- Setpoint, SF step 2
- Setpoint, SF step 3
- Setpoint, EF step 1
- Setpoint, EF step 2
- Setpoint, EF step 3

Operating time

- Supply air fan
- Extract air fan
- Settings.fan

Damper control

- Power down delay
- Damper

Start page



Main menu



Communication

- Comm. modules
- Process bus
- TCP/IP
- Climatix IC
- Modbus
- Modem
- SMS
- Restart



Comm. modules

- Restart
- Module change

Climax IC

- Activate
Serial number
+Status
Communication
Cloud server
Distributor
- Upgrade permitted
Upgrade requested
- Other settings
- System info

SMS

- Current number
- SMS settings
- Modem settings

Process bus

- Address set
Current address
- +TCP/IP
- Multi cast
- Port
Status
Error
- Power supply
+Serial number
Unit family
Unit variant
BSP version
- Other settings

Restart

- Execute
Save/Cancel

Modbus

- Comm. failure
+Internal settings
- RS485
- TCP/IP

TCP/IP

- DHCP
Current IP
Current Mask
Current Gateway
- Set IP
- Set Mask
- Set Gateway
- Primary DNS
Secondary DNS
Name
MAC
Link
100 MB
- Other settings
After value change,
a restart is required
- Restart

Modem

- Modem connected
+Status
Signal strength (GSM)
- PIN
- +Tel. no. 1
- +Tel. no. 2
- +Tel. no. 3
- +Tel. no. 4
- +SMS
- Active no.
- Language
- On alarm reset
Send string
Receive string
- Other settings

Start page

Main menu

General func.

- Summer/winter mode
- Manual operation
- Activate manual alarm
- Activate comm. test
- Communication test
- Set IO to
- Alarm Snapshot
- Snapshot memory full
- Trend archiving
- Trend archive export
- Trend archive full

Summer/winter mode

- Status
Outdoor temperature reduced
- Date/Time, summer
 - Date/Time, winter
 - Time constant
 - Outdoor temperature, summer
 - Outdoor temperature, winter

Communication test

- Manual control
Current value
Alarm
- Alarm configuration
- Alarm class
- Alarm delay
Active priority
- +Operating time, hours
- Reset
Last reset
Date Time
- Other settings
- Order of priority

Trend archive export

- None/Full/Monthly/
Weekly/Now
Save/Cancel

Trend archive full

- Last reset
- Other settings

Manual operation

- Manual control
Current value
Alarm
- Alarm configuration
- Alarm class
- Alarm delay
Active priority
- +Operating time, hours
- Reset
Last reset
Date Time
- Other settings
- Order of priority

Set IO to

- Line test/Auto
Save/Cancel

Alarm Snapshot

- Inactive/Active/
Export/Zero
Save/Cancel

Activate manual alarm

- No/Yes
Save/Cancel

Snapshot memory full

- Last reset
- Other settings

Activate comm. test

- No/Yes
Save/Cancel

Trend archiving

- None/System
Operation/Always
Save/Cancel

Start page



Main menu



Alarm handling

- Alarm reset
 - Danger (A)
 - High (A)
 - Low (B)
 - Warning (C)
- Alarm output selection
- Alarm output 1
- Modbus alarm
- Process bus comm.
- IO exp. bus
- Comm. module 1
 - Communication error
 - Status
- Comm. module 2
 - Communication error
 - Status
- Comm. module 3
 - Communication error
 - Status



Alarm reset

- Execute
- Save/Cancel

Alarm output selection

- High(A)/H+L(A+B)
- Save/Cancel

Alarm output 1

- Manual control
- Current value
- Error
- Active priority
- +Operating time, hours
- Reset
- Last setting
 - Date
 - Time
- Contact function
- Other settings
- Order of priority

Modbus alarm

- Out of operation
- Current value
- Error
- Alarm
- Step error
- Alarm configuration
- Alarm class
- Alarm delay
- +Operating time, hours
- Reset
- Last reset
 - Date
 - Time
- Input/output config.
- Contact function
- Other settings

Process bus comm.

- Manual control
- Current value
- Alarm
- Alarm configuration
- Alarm class
- Alarm delay
- Active priority
- +Operating time, hours
- Reset
- Last reset
 - Date
 - Time
- Other settings
- Order of priority

IO exp. bus

- Response time
- timeout
- Number of retries
- Loop time
- Update time
- Diagnosis

Comm. module 1

- Restart
- Module change

Comm. module 2

- Restart
- Module change

Comm. module 3

- Restart
- Module change

Start page

Main menu

System overview

- Date Time
- Communication
- Application info.
- Versions
- Save/Reset
- Diagnosis
- Trend archiving
- Alarm Snapshot
- Password administration
- HMI
- Language selection



Date Time

- Date/Time
- Save/Cancel

Communication

- Comm. modules
- Process bus
- TCP/IP
- Climatix IC
- Modbus
- Modem
- SMS
- Restart

Application info.

- Site Name
- Street
- City
- Other settings

Versions

- +System info.
- +BSP version
- +Process bus
- +Serial number
- Version

Save/Reset

- SD card
- +Save param.->SD
- +Load param. <-S
- Filter
- Restart
- Save snapshot->
- Save trend->SD
- Load BSP/Apl.<-
- Restore operating settings
- Restore factory settings
- Save operating settings

Diagnosis

- Restart
- Versions
- +Unit name
- Serial number
- Unit ID
- +Number of restarts
- Reset
- Cause
- Internal temperature
- Operating time, hours
- +Create trace file
- Status
- +SD card
- Save trace ->SD
- Save param.->S
- Save snapshot->
- Other settings

Trend archiving

- Status
- Number of current objects
- Number of configured objects
- Reconfigure
- After valuation, a restart is required
- Restart
- Activate
- Save trend ->SD
- Delete all data
- Trend archive full

Alarm snapshot

- Records 01-35
- Records 36-70
- Records 71-100
- Other settings

Password administration

- Enter password
- Close account
- Change password

HMI

- Temperature (ext.)
- HMI language
- Imp. unit system
- Reset when inactive
- Aut. password (ext.)
- Message time: integrated

Language selection

- HMI language
- +Alarm snapshot
- Save -> SD
- +Modem
- SMS language

Start page



Main menu



Overview of IO
config./raw values

- Temperatures
- Pressure/Flows
- Digital inputs
- Digital alarm
- Damper outputs
- Fan outputs
- Temp. control outputs
- Alarm outputs



Temperatures
HV IO:

- Supply air
- Extract air
- Outside

Damper outputs
HV IO:

- Outdoor air damper output
- Exhaust air damper output

Pressure/Flows
HV IO:

- Supply air filter
- Extract air filter

Fan outputs
HV IO:

- Supply air fan output 1

Digital inputs
HV IO:

- External control input 1
- External control input 2

Temp. control outputs
HV IO:

Digital alarm
HV IO:

Alarm outputs
HV IO:

- Alarm output1

Start page

Main menu

Configuration

- Configuration 1
- Configuration 2
- Konfig.In-Utgångar
- IO config. control
 - Duplicated
 - Not configured
- Set IO to
- Overview, Outputs
- Inputs
- Integrations

Configuration 1

- General comment:
- Expansion modules
 - Fire alarm
 - Filter alarm
 - Filter alarm, analogue
 - Emergency stop
 - Alarm reset input
 - SuWi input
 - Timing program function
 - Timing program step
 - External control input
 - Buzzer alarm output
- Sensor:
- Temp. room sensor
 - Extract air temp. sensor
 - Supply air temp. sensor
 - Outdoor temp. sensor
- Functions:
- Damper
 - Extract air fan
 - Fan regulation type
 - Temp. regulation type
 - Mixing damper
 - Heat recovery
 - Heating
 - Electric heating
 - Cooling
 - Extra heating
 - Extra electric heating
 - Extra cooling
 - Fire damper
 - Fire fan
 - External setpoint
 - Configuration 1
 - Restart

Configuration 2

- Nighttime cooling
- Support operation
- Boost
- Support operation/Osstp block
- Damper return
- Dig.step freq.con.
- Flow display
- Fan step type
- Fan alarm
- Fan return
- Fan deviation alarm
- Fan comp. room temp.
- Fan comp. air qual.
- Fan comp. outdoor temp.
- Fan heating/cooling
- Fan Eng. unit
- Ext. Setpoint, fan
- Ext. setpoint function SF
- Ext. setpoint function EF
- Temp. setpoint type
- Temp. deviation alarm
- Summer/Winter comp. temp.
- Recovery frost protection
- Pump/command, recovery
- Recovery alarm
- Cold recovery
- Recovery efficiency
- AUX input
- AUX temp. sensor
- AUX timing program
- AUX output signal
- AUX operating mode ind.
- Configuration 2
- Restart

Config. Inputs/Outputs

- Temperatures
- Pressure/Flows
- Digital inputs
- Digital alarm
- Damper outputs
- Fan outputs
- Temp. control outputs
- Alarm outputs
- Config. Inputs/Outputs
- Restart

Overview, outputs

- Analogue outputs
- Supply air fan
 - Extract air fan
- Digital outputs
- Supply air fan
 - Extract air fan
 - Outdoor air damper
 - Exhaust air damper
 - Alarm output 1

IO config. control

- Non-config.IO
- 1st non-config.IO no.
- Double-config.IO
- Double-config.IO
- Double-config.IO pos.
- Double-config. DO pos.
- Number of unused XI
- Number of unused DI
- Number of unused AO
- Number of unused DO

Set IO to

- Line test/Auto Save/Cancel

Inputs

- +Temperatures
- Extract air
- Supply air
- Outside
- +Pressure/Flows
- Supply air flow
- Extract air flow
- Supply air filter
- Extract air filter
- +Digital alarm
- Supply air fan
- Extract air fan
- Recovery alarm
- Digital inputs

Integrations

- +Room unit
- Settings
- Inputs
- +Energy meter EM24
- Settings
- Inputs
- Flexit MB units
- Settings
- Restart

4. Backup and program updates

When the system has been fully configured and the parameters have been set, it can be backed up to an SD memory card or reset using the data on the memory card.

Two different sets of parameters for a configured system can be backed up or reset. For example, you can back up the standard settings (Save factory settings) and adjusted settings (Save startup settings).

The options below can be selected only with the relevant authority level. This is done using menu option:

Start page > Main menu > System overview > Save/Reset

The regulator has a card slot for an SD memory card with max 8 GB capacity.

4.1. Save a configuration

After initiation and adjustment, the parameters and configurations can be saved to the SD card. For example, you can load these values on another process unit with the same basic configuration (operating system, application, control panel, HMI4Web and language/communication). Authority level 4 is required.



Location of SD memory card

Procedure

1. Insert a blank SD memory card into the regulator.
2. Backup the values to the memory card.

Start page > Main menu > System overview > Save/Reset > Save param.->SD = Execute

3. Wait until:

Start page > Main menu > System overview > Save/Reset > Save param. done = Yes

Standard settings (Factory settings) and adjusted settings (Startup settings) are handled in the same way.

4.2. Load a configuration

Procedure:

1. Insert the memory card into the regulator.
2. Load the values from the memory card.

Start page > Main menu > System overview > Save/Reset > Load param. <-S = Execute

3. Wait until:

Start page > Main menu > System overview > Save/Reset > Load param. done = Yes

4. Restart the process unit:

Start page > Main menu > System overview > Save/Reset > Restart = Execute



Standard settings (Factory settings) and adjusted settings (Startup settings) are handled in the same way.

4.3. Loan an application or software

Preconditions:

- The (uncompressed) files must be in the root folder of the SD memory card.
- The files must have the names shown in the screen below.

Files on SD card

Name	Größe	Typ	Geändert am
OBH.bin	380 KB	BIN File	01.04.2009 17:26
MBRTCode.BIN	297 KB	BIN File	15.04.2009 13:48
HMI.bin	202 KB	BIN File	01.04.2009 17:57
HMI4Web.bin	193 KB	BIN File	01.04.2009 17:57
POL63x.HEX	2'151 KB	HEX File	03.04.2009 15:10
StandardAHU_Vx.zip	1'222 KB	WinZip File	11.05.2009 16:33

Procedure

1. Insert the memory card into the regulator.
2. Switch off the regulator.
3. Press the button in the hole next to the regulator's status screen with a thin object so that a clicking sound is heard, and keep the button pressed down.
4. Switch on the regulator.
5. Wait until the LED flashes red and green.
6. Release the button.
7. Wait until orange LED lights up.
8. Switch off the regulator.
9. Switch on the regulator.

4.4. Error diagnosis - Snapshot

For troubleshooting, the status of the ventilation unit just before the alarm was triggered can be studied afterwards by means of export to an SD card. Authority level 4 is required.

Procedure:

1. Insert a blank SD memory card into the regulator.
2. Backup the error diagnosis to the memory card.

Start page > Main menu > System overview > Save/Reset > Save snapshot = Execute

3. Wait until:

Start page > Main menu > System overview > Save/Reset > Save snapshot = Yes

A file has now been generated on the SD card that can be read from a PC.

5. General functions

Operating modes - Change

The system can be put in different operating modes.

Start page > Main menu > Unit > Operating functions > Continuous operation

Continuous Operation

No	The unit operates in timer mode
Econ.St1	The unit operates at 'Econ' temperature and 'Step 1' speed
Comf.St1	The unit operates at 'Comf' temperature and 'Step 1' speed
Econ.St2	The unit operates at 'Econ' temperature and 'Step 2' speed
Comf.St2	The unit operates at 'Comf' temperature and 'Step 2' speed
Econ.St3	The unit operates at 'Econ' temperature and 'Step 3' speed
Comf.St3	The unit operates at 'Comf' temperature and 'Step 3' speed

6. Configuration

On delivery, the ventilation unit is configured and ready. Normally, therefore, no adjustments need to be made to the configuration.

However, the addition of accessories and other equipment may require a change to the configuration. Where necessary, there is a more detailed description in this manual or with the accessory. This section is, therefore, intended more as general information.

The configuration includes the following four steps:

- Activate and choose type of after heater on circuit board A3
- Configuration 1
- Configuration 2
- Configuration with inputs and outputs

6.1. Configuration 1

If adjustments are needed, 'Configuration 1' is the first step in the configuration.

- Configuration is done sequentially, which means that it is not possible to skip any options.
- Configuration 1 must have been completed and the process unit have been restarted before you continue with Configuration 2.

Start:

If necessary: Enter the password for level 3:

Start page > Log in

Then:

Start page > Main menu > Configuration > Configuration 1

After making a change in a configuration menu, a restart is required.

Start page > Main menu > Configuration > Configuration 1 > Restart > Execute



NB The ventilation unit is supplied fully configured and does not normally need to be changed.

Parameter	Value	Function
General comment:		
Expansion modules	No	Only the process unit's inputs and outputs are used.
	One	One expansion module is connected via address 1. Dipswitches 5 and 6 on the module must be set to On.
	Two	Two expansion modules are connected via addresses 1 and 2. Dipswitch 5 on module 1 and dipswitches 4 and 6 on module 2 must be set to On.
Fire alarm	No	No fire alarm.
	Alarm	External fire alarm such as smoke detectors, thermostat, fire alarm control centre, etc.
	Temp	Internal fire alarm via measurement of normal supply air and extract air temperature when both sensors are accessible. A fire alarm is triggered when one of the two temperatures reaches a specific value.
	Alarm+Temp	Both fire alarms.

Parameter	Value	Function
Filter alarm	No	No filter alarm.
	Comb.	Supply air and extract air filter with common alarm input.
	Supply air	Input only for supply air filter alarm.
	Extract air	Input only for extract air filter alarm.
	Supply+Extract	Two separate filter alarm inputs for supply air and extract air filters.
Filter alarm, analogue	No	No filter alarm.
	Supply air	Analogue input only for supply air filter alarm.
	Extract air	Analogue input only for extract air filter alarm.
	Supply+Extract	Two separate filter inputs for supply air and extract air filters.
Emergency stop	No	Input for emergency stop. If the signal on this input is TRUE, the system is switched off immediately. No alarm is triggered.
	Yes	
Alarm reset input	No	Input for acknowledging or resetting an alarm. Open alarms are acknowledged; closed alarms are reset.
	Yes	
SuWi input	No	Input for summer/winter switching. If the signal on this input is TRUE, summer compensation is selected.
	Yes	
	No heating	No heating in the summer.
	No cooling.	No cooling in the winter.
	Both	No heating in the summer and no cooling in the winter.
Timing program function	No	No timing program.
	Step	Timing program with possible settings for fan steps (Off and Stx). The parameter Timing program step determines the number of possible steps.
	Step+Temp	Timing program with possible settings for fan steps and temperature regulation type (Off, Econ.x and Comf.x). The parameter Timing program step determines the number of possible steps. The temperature mode comfort or economy can be selected for each fan step. Comfort and economy operation have separate setpoints for temperature regulation.
Timing program step	Activation of possible fan steps. This setting controls the number of setpoints for regulated fans.	
	1 Step	Timing program function = Step ---> Possible settings for timing program: Off, St1. Timing program function = Step+Temp ---> Possible settings for timing program: Off, Econ1, Comf1.
	2 Step	Timing program function = Step ---> Possible settings for timing program: Off, St1, St2. Timing program function = Step+Temp ---> Possible settings for timing program: Off, Econ1, Econ2, Comf1, Comf2.
	3 Step	Timing program function = Step ---> Possible settings for timing program: Off, St1, St2, St3. Timing program function = Step+Temp ---> Possible settings for timing program: Off, Econ1, Econ2, Econ3, Comf1, Comf2, Comf3.
External control input	No	No external input for operating mode switching, timer, button, detector for external control, etc.
	One	One input (e.g. on/off).
	Two	Two inputs (e.g. Auto/Off/St1/St2).
Buzzer alarm output	No	No alarm output.
	One	One output (for example for priority alarms).
	Two	Two outputs (for priority and non-priority alarms).
Sensor:		
	Sensor 1	Inputs for room temperature sensors. Select max., min., average or individual value for regulation for one or more sensors in Configuration 2.
	Sensor 2	
	Unit 1	
	Unit 2	

Parameter	Value	Function
Extract air temp. sensor	No	Input for extract air sensor.
	Yes	
	Yes+Max	If the system has been in operation for more than 5 minutes, the max. temperature is saved when it is switched off; otherwise the actual temperature is saved. The setting is meaningful only if there is no room sensor and nighttime operation (for example nighttime cooling) without a temperature test is to be used. This setting should not be used with support operation. (Temperature test: the system is started briefly to update the duct sensor temperature.)
Supply air temp. sensor	No	Input for supply air sensor.
	Yes	
Outdoor temp. sensor	No	Input for sensor for outdoor air temperature.
	Yes	
	Yes+Min.	If the system has been in operation for more than 5 minutes, the min. temperature is saved when it is switched off; otherwise the actual temperature is saved. The setting is meaningful only if a sensor is fitted in the duct and nighttime support operation (for example nighttime cooling) is activated, or as a safety function for pump start at low outdoor air temperatures.
Functions:		
Damper	No	No air damper.
	Comb.	Two air dampers with a common output.
	Outside	Outdoor air damper, one output.
	Outdoor+ Extract air	Two dampers with separate outputs.
Extract air fan	Extract air fan (supply air fan is always available and cannot be deactivated).	
	None	No extract air fan.
	Separate	Extract air fan with separate output.
	Comb.	Extract air and supply air fans with common output.
Fan regulation type	Direct	Up to three digital outputs each for direct-drive fans.
	Dir.fro	Up to three digital outputs each for frequency-regulated fans with fixed steps.
	Fixed freq.	One digital and analogue output each for frequency-regulated fans regulated via modulating analogue outputs (e.g. St1 = 2 V, St2 = 5 V, St3 = 8 V).
	Pressure reg.	One digital and analogue output and one analogue input each for frequency-regulated fans in pressure-regulated systems.
	Flow reg.	One digital and analogue output and one analogue input each for frequency-regulated fans regulated in flow-regulated systems.
	Supply air fan slave	One digital and analogue output each and three analogue inputs for frequency-regulated fans in pressure-regulated systems where the supply air fan is driven depending on the extract air fan.
	Extract air fan slave	One digital and analogue output each and three analogue inputs for frequency-regulated fans in pressure-regulated systems where the extract air fan is driven depending on the supply air fan.

Parameter	Value	Function
Temp. regulation type		Select the regulation algorithm for temperature regulation.
	Supply air	Temperature regulation of supply air only.
	Room casc.	Cascade regulation of room and supply air temperature.
	Extract air casc.	Cascade regulation of extract and supply air temperature.
	Room SuWi	Cascade regulation of room and supply air temperature in summer; regulation of supply air temperature only in winter.
	Extract air SuWi	Cascade regulation of extract and supply air temperature in summer; regulation of supply air temperature only in winter.
	Room	Room regulation only.
	Extract air	Temperature regulation of extract air only.
Mixing damper		Heat recovery regulation with mixing damper.
	No	No mixing damper.
	Normal	Mixing damper with output signal 100% for full circulation.
	Inverted	Mixing damper with output signal 0% for full circulation.
Heat recovery		Select heat recovery regulation with rotating heat exchanger, plate heat exchanger or water heat exchanger.
	No	No heat recovery.
	Rotor	Rotating heat exchanger. One analogue output for regulation of rotating heat exchanger.
	Plate	Plate heat exchanger. One analogue output for regulation of regulating air damper.
	Water	Water heat exchanger. One analogue output for regulation of the valve.
	RotorInv	Rotating heat exchanger. One analogue output for regulation of rotating heat exchanger. Inverted output signal 100% force = 0 V.
	PlateInv	Plate heat exchanger. One analogue output for regulation of regulating air damper. Inverted output signal 100% force = 0 V.
	WaterInv	Water heat exchanger. One analogue output for regulation of the valve. Inverted output signal 100% force = 0 V.
Heating	No	No heating circuit.
	Yes	Heating register without preheating. Analogue heating valve output.
	Yes+Preh. Outdoor temp.	Heating register with preheating. Analogue heating valve output.
	Yes+Preh.Frost protection temp.	Heating register with preheating based on frost protection temperature.
Electric heating		Electric heating register and type of regulation.
	No	No electric heating register available.
	Analogue	Electric heating register with regulation via one analogue output.
	1Step	1-step electric heating register with regulation via one analogue and one digital output.
	2Step	2-step electric heating register with regulation via one analogue and two digital outputs.
	3stepBin	3-step electric heating register with binary regulation via one analogue and two digital outputs.
3step3Rel	Extra 3-step electric heating register with 3 digital outputs.	
Cooling		Select cooling register and type of regulation.
	No	No cooling register.
	Water	One analogue output for cooling valve output.
	DX 1step	One analogue and one digital output for 1-step regulation of DX cooling unit.
	DX 2step	One analogue and two digital outputs for 2-step regulation of DX cooling unit.
	DX 3step	One analogue and two digital (binary) outputs for 3-step regulation of DX cooling unit.

Parameter	Value	Function
Extra heating	No	No extra heating register.
	Yes	Extra heating register without preheating. Analogue heating valve output.
	Yes+Preh. Outdoor temp.	Extra heating register with preheating. Analogue heating valve output.
	Yes+Preh. Frost protection temp.	Heating register with preheating based on frost protection temperature.
Extra electric heating	Extra electric heating register and type of regulation.	
	No	No extra electric heating register available.
	Analogue	Extra electric heating register with regulation via one analogue output.
	1Step	Extra 1-step electric heating register with regulation via one analogue and one digital output.
	2Step	Extra 2-step electric heating register with regulation via one analogue and two digital outputs.
	3stepBin	Extra 3-step electric heating register with binary regulation via one analogue and two digital outputs.
Extra cooling	Extra cooling register and type of regulation.	
	No	No extra cooling register.
	Water	One analogue output for extra cooling valve output.
	DX 1step	One analogue and one digital output for 1-step regulation of extra DX cooling unit.
	DX 2step	One analogue and two digital outputs for 2-step regulation of extra DX cooling unit.
	DX 3step	One analogue and two digital (binary) outputs for 3-step regulation of extra DX cooling unit.
Fire damper	Fire damper.	
	No	No fire damper.
	Yes	One digital output and input each for fire damper regulation.
	Yes+FollUnit	One digital output and input each for fire damper regulation. The fire damper is opened when the unit starts and closed when the unit stops.
	2	Same as 'Yes' but with 2 fire dampers.
	2+FollUnit	Same as 'Yes+FollUnit' but with 2 fire dampers.
	3	Same as 'Yes' but with 3 fire dampers.
	3+FollUnit	Same as 'Yes+FollUnit' but with 3 fire dampers.
	4	Same as 'Yes' but with 4 fire dampers.
Fire fan	No	Fire fan control deactivated.
	Yes	Fire fan control activated.
External setpoint	No	No analogue input for connection of external setpoint or compensation for external setpoint.
	Volt	Input for 0-10 V DC signal.
	Ohm	Input for 0-2500 ohm signal.
	QAA27	Input for QAA27.
	BSG21	Input for BSG21 setpoint compensation.
Configuration 1	With this parameter, the system is activated after parameter settings have been set, i.e. when Configuration 1, Configuration 2 and Config. Inputs/Outputs have been set (value Ready).	
	Not ready	The system is locked and cannot be started.
	Ready	The system is unlocked after the parameter settings have been set (value Ready for Configuration 2 and Config.In/Outputs), i.e. the system can be started.
Restart	Passive Execute	The system must be restarted after parameter settings have been set in Configuration 1. Changed presets in Configuration 2 are implemented. After restart, the value is changed automatically from Execute to Passive.

6.2. Configuration 2

If there is a need for adjustments, subfunctions for some parts of the system can be set in Configuration 2.

Preconditions:

Configuration 1 must have been completed, including restart of the regulator.

- Configuration is done sequentially, which means that it is not possible to skip any options.
- Configuration 2 must have been completed, including restart of the process unit, before you continue with Config. In/Outputs.

Start

If necessary: Enter the password for level 3:

Start page > Log in

Then:

Main menu > Configuration > Configuration 2



NB The ventilation unit is supplied fully configured and does not normally need to be changed.

Parameter	Value	Function
Nighttime cooling	No	The function is not available.
	Yes	Free cooling. Precondition: Nighttime cooling can be selected only if a sensor for outdoor air temperature and a room or extract air sensor are available. Temperature motion is activated automatically if only one extract air sensor, which is set to not hold the values, is available. If the extract air sensor holds the values, the temperature is used to start nighttime cooling.
Support operation	Starts nighttime support operation. Precondition: The function can be selected only if a room or extract air sensor is available. Temperature motion is activated automatically if only one extract air sensor which holds the values is available. If the extract air sensor holds the values, the temperature is used for start.	
	No	The function is not available.
	Heating	The function is available only for heating.
	Cooling	The function is available only for cooling.
	HeatingCooling	The function is available for heating and cooling.
Boost	Optimum start of the system with heating and cooling via separate setpoints. Precondition: The function can be selected only if a room or extract air sensor is available.	
	No	The function is not available.
	Heating	The function is available only for heating.
	Cooling	The function is available only for cooling.
	HeatingCooling	The function is available for heating and cooling.
Support operation/ Osstp block	Block the air damper or extract air fan when the system is started optimally or via temperature delta. NB This function is intended to be used in an emergency situation. Warning! A regulating air damper must be in place and be open when the function is selected. Otherwise, the system may suffer damage.	
	None	No blocking.
	Damper	Air dampers remain closed.
	Dam+Fan	Air dampers remain closed and only the supply air fan is started.
Damper return	No	No damper return.
	One	Return for supply air damper (or common return for both dampers). Digital input for return.
	Two	Separate return for supply air and extract air dampers. Two digital inputs for return.

Parameter	Value	Function
Dig.step freq. con.	1 step	Digital output for activation of frequency-controlled fans (always activated).
	2 step	An extra digital output for alternative connection that is dependent on fan step 2.
	3 step	Two extra digital outputs for alternative connection that is dependent on fan step 3.
Flow display	No	The function is not available.
	l/s	Displays flow in litre/second.
	m ³ /h	Displays flow in m ³ /hour.
Fan step type	Necessary fan regulation output that concerns settings for Fan regulation type, Timing program step and Dig. step freq.conv.	
	Separate	Digital output for each step. Example: Fan regulation type = Direct / Timing program step = 2 / Extract air fan = Yes ---> 4 digital outputs: 2 each for step 1 and step 2, separated for supply air and extract air fans.
	Sep.Comb.	Separate outputs for the first step, common outputs for subsequent steps. Example: Fan regulation type = Pressure reg. / Timing program function = Step+Temp / Timing program step = 3 / Extract air fan = Yes / Dig.step freq.conv = 3. ---> 4 digital outputs: Step 1 as separate activation of frequency-regulated fans, two extra outputs that can be used (Dig.step freq.conv) for step 2 and step 3.
	Binary	The outputs for steps are binarily coded. The setting can be used for Fan regulation type = Direct or Dir.fro. Example: Fan regulation type = Direct / Timing program function = Step+Temp / Timing program step = 3 / Extract air fan = Yes ---> 4 digital outputs: 2 digital outputs each per fan (Step 1 = DO1 TRUE, Step 2 = DO2 TRUE, Step 3 = DO1 and DO2 TRUE).
Fan alarm	Inputs for fan alarm (e.g. thermojunction). Logical 1 = alarm.	
	No	No alarm.
	Comb.	Digital input for common alarm.
	Supply air	Digital input for supply air fan alarm.
	Extract air	Digital input for extract air fan alarm.
	Supply+Extract	Two digital inputs for supply air and extract air fan alarms.
Fan return	Inputs for operating messages from fans (e.g. pressure current guard or relay contact). Logical 1 = activated fan.	
	No	No return.
	Comb.	Digital input for common operating messages.
	Supply air	Digital input for operating messages for supply air fan.
	Extract air	Digital input for operating messages for extract air fan.
	Supply+Extract	Two digital inputs for operating messages for supply air and extract air fans.
Fan deviation alarm	Setpoint or actual value for monitoring pressure or flow. The alarm is triggered in the event of a deviation that remains for a certain period of time.	
	No	No monitoring.
	Supply air	Monitoring of supply air only.
	Extract air	Monitoring of extract air only.
	Supply+Extract	Monitoring of supply and extract air.
Room temp. fan comp.	No	Room temperature-dependent fan compensation.
	Yes	Precondition: Room or extract air sensor activated.
Air qual. fan comp.	No	Air quality-dependent fan compensation. Activation of analogue sensor input.
	Yes	

Parameter	Value	Function
Outdoor temp. fan comp.	No	Outdoor air temperature-dependent fan compensation. Precondition: Outdoor air sensor activated.
	Yes	
Fan heating/cooling		The fan is used as heating or cooling sequence.
	No	No sequential fan activation.
	Heating	Fan activation only in connection with heating sequence.
	Cooling	Fan activation only in connection with cooling sequence.
	HeatingCooling	Fan activation in connection with both sequences.
Ext. Setpoint, fan	No	Function deactivated.
	SF	The supply air fan is regulated via an external setpoint.
	EF	The extract air fan is regulated via an external setpoint.
	SF + EF	Both the supply air and extract air fans are regulated via an external setpoint.
Ext. setpoint function SF	Comp.	Setpoint compensation.
	Main	Main setpoint.
Ext. setpoint function EF	Comp.	Setpoint compensation.
	Main	Main setpoint.
Temp. setpoint type	Predefined settings for temperature setpoints:	
	Heating+Dz	Enter heating setpoint and dead zone. Setpoint for cooling = heating setpoint + dead zone.
	HeatingCooling	Setpoints for heating and cooling are entered directly.
	Setpoint+HalfDz	Enter base setpoint and dead zone. Heating setpoint = base setpoint – half dead zone. Setpoint for cooling = base setpoint + half dead zone.
	Cooling Dz	Enter setpoint for cooling and dead zone. Heating setpoint = setpoint for cooling – dead zone.
Temp. deviation alarm	Monitors setpoint/current value for temperature. The alarm is triggered in the event of a deviation that remains for a certain period of time.	
	No	No monitoring
	Supply air	Monitoring of supply air only.
	Room/Extract air	Room and extract air temperature.
	Supply+Room	Monitoring of supply air and room temperature.
Summer/Winter comp. temp.	No	Summer/winter compensation of temperature setpoint. Precondition: Sensor for outdoor air temperature must be available.
	Yes	
Recovery frost protection	No	No frost protection for heat recovery.
	Guard	Frost protection via guard. Digital input for frost guard.
	Temp.	Frost protection via sensor. One analogue input for regulated frost protection via setpoint. Rotating heat exchanger and plate heat exchanger: extract air sensor, water heat exchanger: water sensor.
	Temp+Guard	Frost protection via sensor and guard. One analogue input for regulated frost protection and one digital input for frost guard.
	Pressure	Frost protection via pressure sensor. One analogue input for regulated frost protection via setpoint.
	Pressure+Guard	Frost protection via pressure sensor and guard. One analogue input for regulated frost protection and one digital input for frost guard.
Pump/command, recovery	No	No pump.
	Yes	Pump without.
	Yes+Motion	The extract air fan is regulated via an external setpoint.

Parameter	Value	Function
Recovery alarm	No	No alarm.
	Alarm	Alarm: activation of one digital alarm input: Logical 1 = alarm.
	Return.	Return signal. A digital input for return. Pulse in connection with operation.
	Alarm+Return	Pump with alarm and return. Two digital inputs for pump alarm and return.
Cold recovery	Type of cold recovery.	
	No	No cold recovery.
	Temp	Cooling recovery via difference between outdoor and indoor temperatures.
	Outdoor enthalpy	Cooling recovery via difference between outdoor and indoor enthalpies.
Recovery efficiency	Calculation of heat recovery efficiency. Precondition: Heat recovery (e.g. rotating heat exchanger) must be activated and there must be a sensor for both outdoor air temperature and extract air.	
	No	No calculation of heat recovery efficiency.
	Exhaust air	For calculation with extract air sensor: One analogue input for the extract air sensor unless the frost guard has been activated.
	Supply air	For calculation with the supply air sensor located immediately behind the heat exchanger: One analogue input for extra supply air sensor.
Aux. input	No	No aux input.
	Input	Extra digital input for display only.
	Alarm	Extra digital input with alarm.
	Inp.+Alarm	Two extra digital inputs; one for display and one with alarm.
Aux. temp. sensor	No	No extra analogue input.
	Yes	Extra analogue input for connection of temperature display.
Aux. timing program	No	No extra digital output.
	Yes	One digital aux. output with separate timing program.
Aux. output signal	No	No extra analogue output.
	Fan	Analogue output that generates a 0-10 V signal, depending on current fan step.
	Flow device	Analogue output that generates a 0-10 V signal, depending on temperature.
Aux. operating mode input	No	No extra digital output.
	Yes	An extra digital output, the status of which depends on the current operating mode (e.g. Comfort or Off).
Configuration 2	With this parameter, the system is activated after parameter settings have been set, i.e. when Configuration 1, Configuration 2 and Config. Inputs/Outputs have been set (value Ready).	
	Ready	The system is unlocked after the parameter settings have been set (value Ready for Configuration 2 and Config.In/Outputs), i.e. the system can be started.
	Not ready	The system is locked and cannot be started.
Restart	Execute	The system must be restarted after parameter settings have been set in Configuration 2. Changed presets in Config. Inputs/Outputs are applied. After restart, the value is changed automatically from Execute to Passive.
	Passive	

6.3. Configuration of inputs and outputs

If there is a need for adjustments, subfunctions for some parts of the system can be set in Configuration 1, Configuration 2 and Configuration of inputs and outputs.

In Config.In/Outputs, a physical location is assigned to the inputs and outputs specified in Configuration 1 and Configuration 2. Parameter settings are also set for the relevant sensor conversion (e.g. Ni1000, Pt1000, 0-10 V = 0-1,000 Pa).

Positions in regulator and expansion modules

- Regulator: All single-digit positions, for example X1.
- Modbus extender: xxxxx
- Expansion module 1: All positions X1x, DI1x, DO1x, AO1x, for example X11, DO14.
- Expansion module 2: All positions X2x, DI2x, DO2x, AO2x, for example X21, DO24.

Preconditions

Configuration 1 and Configuration 2 must be ready (the process unit must be restarted after each configuration).

Start

If necessary: Enter the password for level 3:

Start page > Log in

Then:

Start page > Main menu > Configuration > Config. Inputs/Outputs



NB The ventilation unit is supplied fully configured and does not normally need to be changed.



NB The inputs and outputs in the expansion modules can be used if the module has been activated in Configuration 1.

Parameter	Value	Function
Temperatures		Go to the hardware configuration page for all temperature sensors.
Pressure/Flows		Go to the hardware configuration page for all pressure and flow sensors.
Digital inputs		Go to the hardware configuration page for all digital inputs without alarm function.
Digital alarm		Go to the hardware configuration page for all digital inputs with alarm function.
Damper outputs		Go to the hardware configuration page for supply air, extract air and fire dampers.
Fan outputs		Go to the hardware configuration page for fans.
Temp. control outputs		Go to the hardware configuration page for heating, cooling, heat recovery, etc.
Alarm outputs		Go to the hardware configuration page for both alarm outputs.
Config. Inputs/Outputs		Activation of the system after parameter settings have been set, i.e. when Configuration 1, Configuration 2 and Config. Inputs/Outputs have been set (value Ready).
	Ready	The system is unlocked after the parameter settings have been set and can be started.
	Not ready	The system is locked and cannot be started.
Restart	Passive Execute	The system must be restarted after parameter settings have been set in Config. Inputs/Outputs. Changed presets in Config.In/Outputs are implemented. After restart, the value is automatically changed back.

7. Cooling

DX cooling one step or liquid

The unit is equipped by default to control liquid cooling or one DX step. If another two steps are required, expansion module SP90 must be installed. Cooling control according to the following instructions.

7.1. Installation

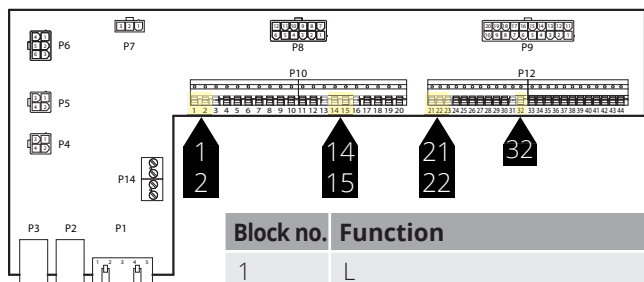

Block no.	Function
1	L
2	N
14	DX cooling/cooling pump IN
15	DX cooling/cooling pump OUT
21	Cooling - 0-10 V [AO]
22	Cooling - G0
32	+24 V supply

7.2. Configuration - Cooling control

Now use the control panel to configure the unit for DX cooling control or liquid.

Start page > Main menu > Configuration > Configuration 1 > Cooling

Parameter	Function
No	Cooling control deactivated
Water	Cooling control via liquid battery
DX 1step	Cooling control via DX machine, one step
DX 2step	Cooling control via DX machine, two steps, requires expansion module SP90
DX 3step	Cooling control via DX machine, three steps, requires expansion module SP90

After making a change in a configuration menu, a restart is required.

Start page > Main menu > Configuration > Configuration 1 > Restart > Execute



7.3. For activation of circulation pump (only applies to liquid cooling)

Start page > Main menu > Configuration > Configuration 2 > Pump/cooling

Parameter	Function
No	Pump control deactivated
Yes	Pump control activated
Yes + Motion	Pump control activated + maintenance operation

To perform parameter settings, use the menus below via the control panel.

7.4. Blocking in connection with outdoor temperature

Start page > Main menu > Unit > Temperature regulation > Cooling > Block in connection with outdoor temperature

Parameter	Function
-64.0 to 64.0	Indicates the lowest permitted outdoor temperature for cooling operation

7.5. Operating times (only applies to DX cooling)

Start page > Main menu > Unit > Temperature regulation > Cooling > Direct expansion > Min. operating time

Parameter	Function
0 to 3,600	Indicates the minimum OPERATING TIME of the DX machine after start

Start page > Main menu > Unit > Temperature regulation > Cooling > Direct expansion > Min. idle time

Parameter	Function
5 to 600	Indicates the minimum IDLE TIME of the DX machine after stop

7.6. Cooling restriction depending on fan speed (only applies to DX cooling)

Start page > Main menu > Unit > Temperature regulation > Cooling > Max. signal, fan control

Parameter	Function
Fan step 1 > 0-100%	Permitted DX cooling output signal when the unit operates on step 1 or uses the setpoint for step 1
Fan step 2 > 0-100%	Permitted DX cooling output signal when the unit operates on step 2 or uses the setpoint for step 2
Fan step 3 > 0-100%	Permitted DX cooling output signal when the unit operates on step 3 or uses the setpoint for step 3

> EXAMPLE OF COOLING RESTRICTION

<i>Fan step 1 = 30%</i>	<i>The automatic control limits the cooling force to 30% at fan step 1.</i>
<i>Fan step 2 = 60%</i>	<i>The automatic control limits the cooling force to 60% at fan step 2.</i>
<i>Fan step 3 = 100%</i>	<i>No cooling force restriction at fan step 3.</i>

7.7. Setting of temperature setpoint

Start page > Quick menu > Setpoints/Settings

Parameter	Function
Setp.comf.cooling	Indicates the temperature setpoint for comfort operation
Setp.econ.cooling	Indicates the temperature setpoint for economy operation

8. Temperature regulation

8.1. Extract air regulation

The unit is configured by default to regulate temperature via the supply air. However, it can be reconfigured to regulate via the extract air. To do this, go to the following menu.

Start page > Main menu > Configuration > Configuration 1 > Temperature regulation type

Parameter	Function
Supply air	Temperature regulation is controlled by the supply air temperature.
Extract air	Temperature regulation is controlled by the extract air temperature.

After making a change in a configuration menu, a restart is required.

Start page > Main menu > Configuration > Configuration 1 > Restart > Execute



8.2. To adjust supply air temperature limits with extract air regulation.

Start page > Quick menu > Setpoints/Settings

Parameter	Function
Setpoint, min. supply air temp.	Indicates the lowest permitted supply air temperature
Setpoint, max. supply air temp.	Indicates the highest permitted supply air temperature

9. Summer/winter compensation

Summer compensation:

Adjusts the fan/temperature setpoint (in relation to regulation, supply air or extract air) in relation to regulation for high outdoor air temperature in the summer.

Winter compensation:

Adjusts the fan/temperature setpoint (in relation to regulation, supply air or extract air) in relation to regulation for low outdoor air temperature in the winter.

9.1. Adjustment of fan setpoint in connection with high/low outdoor temperature

Start page > Main menu > Configuration > Configuration 2 > Fan comp., outdoor temp.

Parameter	Function
No	Function deactivated
Yes	Function activated

After making a change in a configuration menu, a restart is required.

Start page > Main menu > Configuration > Configuration 2 > Restart > Execute



9.2. Parameter settings for fan compensation

Start page > Main menu > Unit > Fan control > Summer/Winter compensation

Parameter	Function
Outdoor temperature start	Outdoor temperature when the compensation is activated
Outdoor temperature finish	Outdoor temperature when the highest (summer) or lowest (winter) fan setpoint is achieved
Delta	Setpoint offset in %. Example with flow regulation and summer compensation: Fan setpoint start = 500 l/s Outdoor temperature start = 20 degrees Outdoor temperature finish = 30 degrees Delta = 20% Fan setpoint finish (at 30 degrees) = 600 l/s

9.3. Adjustment of temperature setpoint in connection with high/low outdoor temperature

Start page > Main menu > Configuration > Configuration 2 > SuWi comp.temp

Parameter	Function
No	Function deactivated
Yes	Function activated

After making a change in a configuration menu, a restart is required.

Start page > Main menu > Configuration > Configuration 2 > Restart > Execute



9.4. Parameter settings for temperature compensation

Start page > Main menu > Unit > Temperature regulation > Temperature setpoint > Summer/Winter compensation

Parameter	Function
Outdoor temperature start	Outdoor temperature when the compensation is activated
Outdoor temperature finish	Outdoor temperature when the highest (summer) or lowest (winter) fan setpoint is achieved
Delta	Setpoint offset in degrees. Example with temperature regulation and summer compensation: Temperature setpoint start (at 20 degrees) = 22 degrees Outdoor temperature start = 20 degrees Outdoor temperature finish = 30 degrees Delta = -5 degrees Temperature setpoint finish (at 30 degrees) = 17 degrees

9.5. Settings for switching between summer and winter operation

Switches between extract air regulation in the summer and supply air regulation in the winter.

Start page > Main menu > Configuration > Configuration 1 > Temp. regulation type

Parameter	Function
Extract air SuWi	Extract air regulation in summer and supply air regulation in winter
Room SuWi	Room regulation in summer and supply air regulation in winter. NB Requires room sensors

9.6. Switch between summer and winter via signal

Start page > Main menu > Configuration > Configuration 1 > SuWi input

Parameter	Function
No	Function deactivated
Yes	Switches between summer and winter operation. 1 = Summer & 0 = Winter
No heating	Yes + Heating deactivated in the summer
No cooling.	Yes + Cooling deactivated in the winter
Both	Yes + Heating deactivated in the summer & Cooling deactivated in the winter

After making a change in a configuration menu, a restart is required.

Start page > Main menu > Configuration > Configuration 1 > Restart > Execute



A physical input must then be connected to the function. There are various inputs to choose between, fire damper return (fire damper is installed) and external speed control. If the fire damper return is activated, the input for speed control is used, and vice versa.

Start page > Main menu > Configuration > Config. Inputs/Outputs > Digital inputs > SuWi input

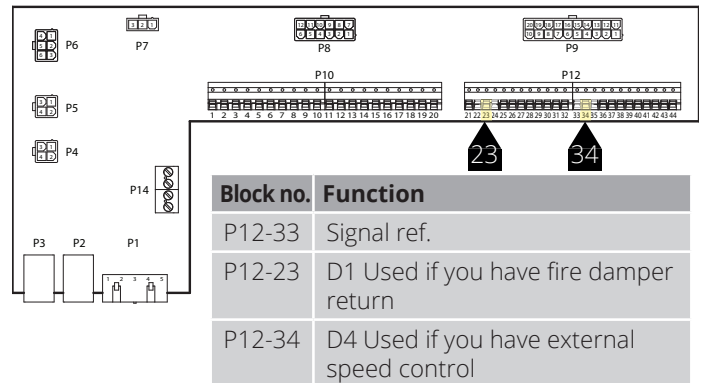

Parameter	Function
D1	Used if you have fire damper return
D4	Used if you have external speed control

If D1 is selected, the external speed control function must be deactivated.

Start page > Main menu > Configuration > Configuration 1 > External control input > No

After making a change in a configuration menu, a restart is required.

Start page > Main menu > Configuration > Configuration 1 > Restart > Execute



9.7. Switch between summer and winter via date/outdoor temperature

Start page > Main menu > General functions > Summer/winter mode

Parameter	Function
Status	Display of current operating mode
Outdoor temperature reduced	Average outdoor air temperature over given time constant
Date/Time, summer	Date/time for switching to summer operation. If * is indicated instead of date/time, switching is on Outdoor temperature reduced
Date/Time, winter	Date/time for switching to winter operation. If * is indicated instead of date/time, switching is on Outdoor temperature reduced
Time constant	Time constant for calculation of Outdoor temperature reduced. Set to 0 for ten seconds for reset of reduced outdoor temperature. Set constantly to 0 for switching on current outdoor temperature
Outdoor temp. Summer	Outdoor temperature for switching to summer operation
Outdoor temp. Winter	Outdoor temperature for switching to winter operation

> EXAMPLE

Outdoor air temp. moderated = shows average temperature over the last X hours (24 in this case)
*Date/Time. Summer = **
*Date/Time. Winter = **
Time constant = 24
Outdoor air temp. Summer = 15
Outdoor air temp. Winter = 12
If the average temperature is over 15 degrees for 24 hours, the control system switches to summer operation. If the average temperature is under 12 degrees for 24 hours, the control system switches to winter operation. If date and time are shown instead, this will override the temperature settings and the control system will switch to date/time instead.

9.8. Temperature test for nighttime operation

A temperature test starts the system after an extended period of inactivity to update the duct sensor's temperature. This temperature is used as the criterion for starting nighttime cooling or support operation and must always be kept up to date.

The function is activated automatically when the following conditions are met:

There is no room sensor:

Start page > Main menu > Configuration > Configuration 1 > Room sensor temp. = No

Nighttime cooling or support operation is activated:

Start page > Main menu > Configuration > Configuration 2 > Nighttime cooling > Yes

Or:

Start page > Main menu > Configuration > Configuration 2 > Support operation > No

After making a change in a configuration menu, a restart is required.

Start page > Main menu > Configuration > Configuration 2 > Restart > Execute



> EXAMPLE OF NIGHTTIME COOLING

Room setpoint = 22
Hysteresis = 2
Delta = 5
Min. outdoor air temp. = 10
Min. operating time = 30
When a temperature test is carried out, the room/extract air is >24 degrees and the outdoor temperature is between 10 and 17 degrees.
The system starts and stops only when the room/extract air is 22 degrees and at least 30 minutes have passed since the start.

Configure as follows.

Start page > Main menu > Unit > Operating functions > Nighttime operation temp. test

Parameter	Function
Motion time	Time of temperature test
Interval time	How often the temperature test is required
Pulse time	Operating time for temperature test. NB Not shorter than 180 seconds

> EXAMPLE OF TEMPERATURE TEST

Motion time = 23:00
Interval time = 3
Pulse time = 300
The system is switched on for 300 seconds if it has been switched off for at least three hours from 23:00
*NB Motion time = *:* and interval time = 0.0 = No temperature test is carried out.*

9.9. Nighttime cooling

Configure as follows:

Start page > Main menu > Configuration > Configuration 2 > Nighttime cooling

Parameter	Function
Yes	Function activated
No	Function deactivated

Start page > Main menu > Unit > Operating functions > Nighttime cooling

Parameter	Function
Room setpoint	Displays the current setpoint for room/extract air
Hysteresis	Hysteresis for power up (Power up = Room setpoint + Hysteresis).
Delta	Minimum difference between room/extract air and outdoor temperature
Min. outdoor temp.	Lowest permitted outdoor temperature to activate nighttime cooling
Min. operating time	Shortest operating time in minutes after start of nighttime cooling has been activated

9.10. Support operation

Nighttime support operation prevents the building from being heated or cooled too much. This is regulated via a separate setpoint for heating and cooling.

9.10.1. To activate the function

Start page > Main menu > Configuration > Configuration 2 > Support operation

Parameter	Function
No	Function deactivated
Heating	Function activated for heating
Cooling	Function activated for cooling
HeatingCooling	The function is activated for both heating and cooling

After making a change in a configuration menu, a restart is required.

Start page > Main menu > Configuration > Configuration 2 > Restart > Execute



9.10.2. To configure the function

Start page > Main menu > Operating functions > Support operation

Parameter	Function
Start cooling	Start temperature for cooling, extract air > Start cooling
Setpoint for cooling	Supply air setpoint for activated support operation cooling
Start heating	Start temperature for heating, extract air > Start heating
Setpoint for cooling	Supply air setpoint for activated support operation cooling
Hysteresis	Hysteresis for power down: For cooling: Extract air < Start cooling - Hysteresis For heating: Extract air < Start heating + Hysteresis
Min. restart time	Shortest power down time after heating or cooling has been activated
Min. operating time	Shortest operating time after start

> EXAMPLE OF SUPPORT OPERATION COOLING

Start cooling = 25 degrees

Setpoint for cooling = 16 degrees

Hysteresis = 3 degrees

Min. restart time = 30 min.

Min. operating time = 15 min.

When a temperature test is carried out, the extract air is 26 degrees. The unit then switches to support operation cooling and regulates the supply air to 16 degrees. The system stops when the extract air has fallen to 22 degrees (Start cooling – Hysteresis), but no earlier than after 15 minutes. Support operation starts again at the earliest after 30 minutes after the last stop.

10. Fan regulation

10.1. Select method of regulation

10.1.1. Selection fan regulation method

All fan regulation functions are selected under the menu option:

Start page > Main menu > Configuration > Configuration 1 > Fan regulation type

'Flow regulation' is selected by default.



NB The options 'Direct' and 'Dir. fro' must not be used!

10.1.1.1. Fixed frequency

Frequency-controlled fans controlled with fixed steps via analogue outputs [%].

After making a change in a configuration menu, a restart is required.

Start page > Main menu > Configuration > Configuration 1 > Restart > Execute



RESTART

Set parameters in the menu option:

Start page > Main menu > Unit > Setpoints/Settings

10.2. Pressure control

Before pressure control is selected, one or two pressure sensors must be installed and connected to the unit. If pressure sensors from Flexit are used, they must be connected to P5 and P4. See the manual for the accessory. If other makes are used, they must be connected to block P12. See table.

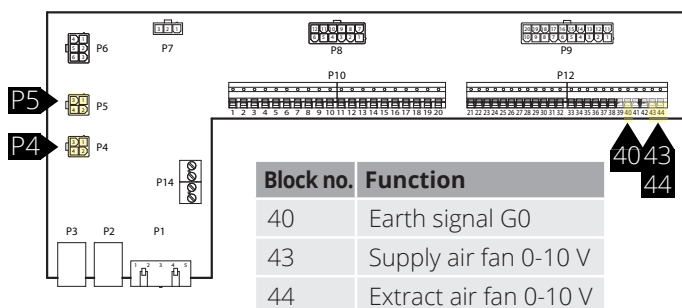

Now use the control panel to configure the unit for pressure control.

Start page > Main menu > Configuration > Configuration 1 > Fan regulation type

Parameter	Function
Pressure reg.	Requires 2 pressure sensors. The fans are adjusted individually to their respective setpoints
Supply air fan slave	Requires 1 pressure sensor for the extract air fan. The supply air fan follows the extract air fan with an adjustable slave offset
Extract air fan slave	Requires 1 pressure sensor for the supply air fan. The extract air fan follows the supply air fan with an adjustable slave offset

After making a change in a configuration menu, a restart is required.

Start page > Main menu > Configuration > Configuration 1 > Restart > Execute



RESTART

10.2.1. Configuration of the pressure sensors' measuring ranges

Start page > Main menu > Configuration > Config. Inputs/Outputs > Pressure/Flows > Supply air pressure

Parameter	Function
X6 500 Pa	X6 = Physical input (must not be changed). 500 Pa = Max. set value of connected pressure sensor.
Type 0-10 V	Type of signal. Must not be changed.

Start page > Main menu > Configuration > Config. Inputs/Outputs > Pressure/Flows > Extract air pressure

Parameter	Function
X7 500 Pa	X7 = Physical input (must not be changed). 500 Pa = Max. set value of connected pressure sensor.
Type 0-10 V	Type of signal. Must not be changed.

10.2.2. Pressure setpoint adjustment.

If SF or EF is selected to operate as a slave, only three setpoint steps are displayed.

Start page > Quick menu > Setpoints/Settings

Parameter	Function
Setp.TF step 1	Supply air fan setpoint speed 1
Setp.TF step 2	Supply air fan setpoint speed 2
Setp.TF step 3	Supply air fan setpoint speed 3
Setp.FF step 1	Extract air fan setpoint speed 1
Setp.FF step 2	Extract air fan setpoint speed 2
Setp.FF step 3	Extract air fan setpoint speed 3

If SF slave or EF slave is selected for the fan regulation type, an offset must be set against which the fan selected is regulated.

The supply air/extract air fan is pressure-regulated. The supply air/extract air flow is calculated and regulated against the slave offset. See example.

Start page > Main menu > Unit > Fan control > Slave offset

Explanation: The offset indicates the difference between the master fan and the slave fan.

> EXAMPLE OF OFFSET

Example 1:	If the offset is 0 l/s, the slave fan operates with the same flow as the master fan.
Example 2:	If the offset is -100 l/s, the slave fan operates with 100 l/s lower flow than the master fan.
Example 3:	If the offset is 100 l/s, the slave fan operates with 100 l/s higher flow than the master fan.

10.3. External fan setpoint

The fans can be controlled directly via an analogue 0-10 V input on the automatic control. Min. and max. speeds/flows are defined, which correspond to 0 V and 10 V on the input.

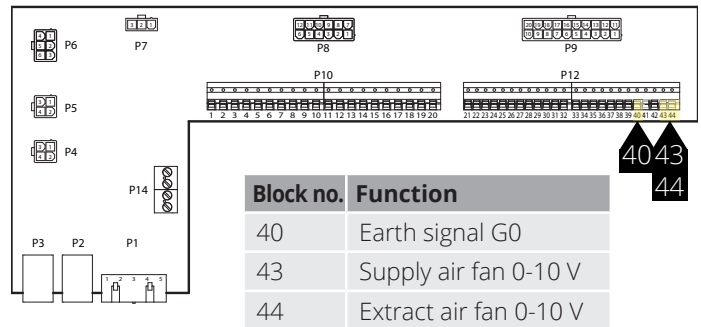

Activated via the following menu option:

Start page > Main menu > Configuration > Configuration 2 > Ext. Setpoint, fan

Parameter	Function
No	Not activated
SF	External control of supply air fan
EF	External control of extract air fan
SF + EF	External control of both supply air and extract air fans

After making a change in a configuration menu, a restart is required.

Start page > Main menu > Configuration > Configuration 2 > Restart > Execute



The function has two operating modes:

1. Comp. A basic flow via step 1, 2 or 3 on which the fan operates + comp.
2. Main. The fan is controlled only via the 0-10 V input and steps 1, 2 and 3 are inactive.

Start page > Main menu > Configuration > Configuration 2 > Ext. setpoint function SF/EF

Parameter	Function
Comp.	Example of Comp. Comp. is set to 0 V = 0 l/s and 10 V = 500 l/s Step 1 is set to 100 l/s and the input for the external setpoint is 0 V. The fan operates at 100 l/s Step 2 is set to 300 l/s and the input for the external setpoint is 10 V. The fan operates at 800 l/s
Main	Example of Main. Main is set to 0 V = 100 l/s and 10 V = 1,000 l/s The input for the external setpoint is 0 V. The fan operates at 100 l/s The input for the external setpoint is 5 V. The fan operates at 500 l/s

After making a change in a configuration menu, a restart is required.

Start page > Main menu > Configuration > Configuration 2 > Restart > Execute



After the restart, the unit starts with an alarm: 'External SF/EF setpoint config. error'. This means that one or two physical inputs must be defined for the function. This is done via:

Start page > Main menu > Configuration > Config. Inputs/Outputs > Other > Ext. Setpoint, SF

Parameter	Function
X6	Defines the input to which the function must be connected

Start page > Main menu > Configuration > Config. Inputs/Outputs > Other > Ext. Setpoint, EF

Parameter	Function
X7	Defines the input to which the function must be connected

After making a change in a configuration menu, a restart is required.

Start page > Main menu > Configuration > Config. Inputs > Restart > Execute



10.3.1. Parameter settings for Comp.

Start page > Quick menu > Setpoints/Settings > All settings > Fan control > Supply air fan/Extract air fan

Parameter	Function
Current setpoint supply air/extract air	Displays the current setpoint for the supply air/extract air fan, including compensation.
Step 1	Supply air/extract air fan setpoint speed 1
Step 2	Supply air/extract air fan setpoint speed 2
Step 3	Supply air/extract air fan setpoint speed 3
Ext. setpoint curve Y1	Scaling of the 0-10 V signal, speed/flow at 0 V
Ext. setpoint curve Y2	Scaling of the 0-10 V signal, speed/flow at 10 V
External setpoint SF/EF	Displays the current setpoint for the 0-10 V input

10.3.2. Parameter settings for Main

Start page > Quick menu > Setpoints/Settings > All settings > Fan control > Supply air fan/Extract air fan

Parameter	Function
Current setpoint supply air/extract air	Displays the current setpoint for the supply air/extract air fan
Step 1	Not active
Step 2	Not active
Step 3	Not active
Ext. setpoint curve Y1	Scaling of the 0-10 V signal, speed/flow at 0 V
Ext. setpoint curve Y2	Scaling of the 0-10 V signal, speed/flow at 10 V
External setpoint SF/EF	Displays the current setpoint for the 0-10 V input

10.4. External fan control via digital inputs

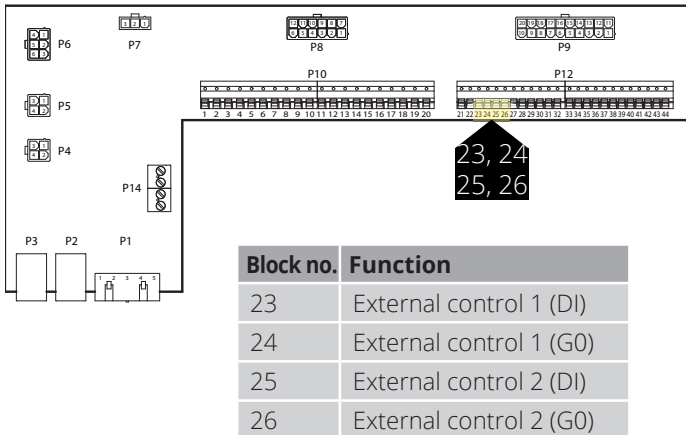

Connection of signal(s) for controlling fan speeds from external components. It is possible to connect various types of switch/sensor that have pulse or fixed positions. By default the regulator is set for switches with fixed values.

> EXAMPLE OF EXTERNAL CONTROL

Control 1	ON = Speed 1
Control 2	ON = Speed 2
Controls 1 & 2	ON = Speed 3

Speed 3 can be configured to Stop. This is done via:

Start page > Main menu > Unit > Operating functions > External control > Fan step

Parameter	Function
Off	External inputs 1 and 2 ON produce stop

10.5. Fire fan

The unit has a potential-free output to control an external fire fan. This requires the expansion module SP90 to be installed.

11. Connection of external equipment

11.1. Fire damper

The unit can control fire dampers and operate them for maintenance. Fire dampers can be included in the system control, either via autotest or always open. Defined limit positions are monitored. The current status and operating mode of the dampers are displayed.

To activate the function.

Start page > Main menu > Configuration > Configuration 1 > Fire damper

Parameter	Function
No	Function deactivated
Yes	Function activated. One digital output and input each for fire damper regulation
Yes + FollUnit	Function activated. One digital output and input each for fire damper regulation. The fire damper is opened when the unit starts and closed when the unit stops.
2-4	Same as 'Yes' but with 2-4 fire dampers
2-4 + FollUnit	Same as 'Yes+FollUnit' but with 2-4 fire dampers

After making a change, a restart is required.

Start page > Main menu > Configuration > Configuration 1 > Restart > Execute



Continue to configure the return of the fire damper.

Start page > Main menu > Configuration > Configuration 2 > Fire damper return

Parameter	Function
Closed	Only one return for closed damper.
Clo + Op	Two separate returns for open and closed positions.
Combi	Returns for open and closed modes, but only one signal/input with sequence as below: 1 (closed) ---> 0 (closes/opens) ---> 1 (open)

After making a change in a configuration menu, a restart is required.

Start page > Main menu > Configuration > Configuration 2 > Restart > Execute



Connection description for fire damper indication with combined signal for open and closed.

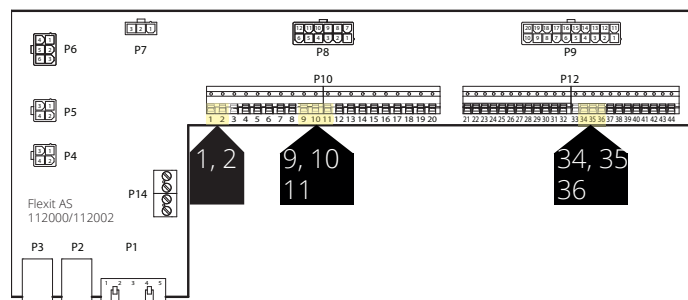
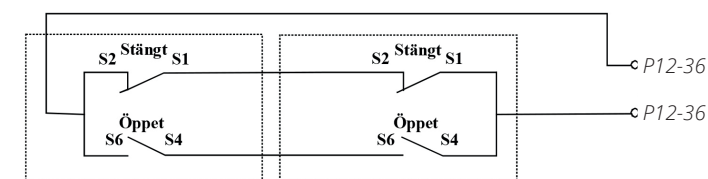

Block no.	Circuit board 112000 Function
P10-9	L (Fire damper)
P10-10	L1 (Fire damper ON/OFF)
P10-11	N (Fire damper)
P12-34	Fire damper open [DI]
P12-35	Fire damper closed [DI]
P12-36	Fire damper - G0

Block no.	Circuit board 112002 Function
P10-9	C Potential-Free Contact Fire damper ON/OFF
P10-10	NO Potential-Free Contact Fire damper ON/OFF
P10-11	NO Potential-Free Contact Fire damper ON/OFF
P10-1	L Voltage supply
P10-2	N Voltage supply
P12-34	Fire damper open [DI]
P12-35	Fire damper closed [DI]
P12-36	Fire damper - G0

The fire dampers must be connected according to the above diagram to ensure correct operation. In the case of a common signal for open/closed, connect between P12-35 and P12-36.

Configure as follows.

Start page > Main menu > Unit > Damper control
> Fire damper

Parameter	Value	Function
Operation	Off	Current status of outdoor air damper.
	On	Go to the page for all settings for digital outputs.
Return open mode	OK	Active return if the damper is open. The parameter is activated automatically after 115% of the time in open mode if return for open mode is not activated in Configuration 2.
	1 / 2 / 3 / 4 + all possible combinations	The figures indicate which damper has an error.
Return closed mode	OK	Active return if the damper is closed. This must always be set.
	1 / 2 / 3 / 4 + all possible combinations	The figures indicate which damper has an error.
No movement	OK Alarm	No reaction to the alarm message for both returns if the damper operation has been changed. See example below.
Status	N/A	Possible only in connection with configuration.
	Closed	Closed.
	Cl/Op	Closes/opens.
	Open	Open. See example below.
Operating mode	N/A	Possible only in connection with configuration.
	OK	OK.
	Test	Test mode.
	Alarm	Alarm mode.
Open time	1...600 [s]	Time for damper opening (see product sheet for damper actuator).
Close time	1...600 [s]	Time for damper closing (see product sheet for damper actuator).
Start manual test	Passive	The time for automatic start of the damper test. Autotest is deactivated for Configuration 1 > Fire damper = Yes+FollUnit. See example below.
	Active	
Motion	Time, Weekday, Date	The time for automatic start of the damper test. Autotest is deactivated for Configuration 1 > Fire damper = Yes+FollUnit. See example below.
Test interval	0...36000 [h]	Time interval for automatic damper test. See example below.

> EXAMPLE OF DAMPER OPERATION 0 -> 1:

After 15% of the time in open mode, return must be Closed	Otherwise an alarm is triggered for no movement.
After 115% of the time in open mode, return must be Open	Otherwise a return alarm is triggered for open mode Damper operation 1 -> 0.

> EXAMPLE OF DAMPER OPERATION 1 -> 0:

After 15% of the time in closed mode, return must be Open	Otherwise an alarm is triggered for no movement.
After 115% of the time in closed mode, return must be Closed	Otherwise a return alarm is triggered for closed mode.

An automatic test can be carried out at a certain time (day, time) and/or at a certain interval.

> EXAMPLE OF TEST INTERVAL:

Motion = *:* *,* */ Test interval = 24	A test is carried out every 24 hours, regardless of the time
Motion = 23:* Mo,* */ Test interval = 47 h	A test is carried out every month at 23:00, with the previous test having been carried out at least 47 hours earlier.
Motion = *:* *,* */ and Autotest interval = 0	No automatic test is carried out. Test sequence = 1

Test mode; the entire unit stops. After the Power down delay period, the outdoor air and extract air dampers are closed and a fire damper test is initiated.

> EXAMPLE OF SWITCH TO 1 -> 0:

After 15% of the time in closed mode, return must be Open	Otherwise an alarm is triggered for no movement.
After 115% of the time in closed mode, return must be Closed	Otherwise a return alarm is triggered for closed mode.

If everything works as intended:

> EXAMPLE OF SWITCH TO 0 -> 1:

After 15% of the time in open mode, return must be closed	Otherwise an alarm is triggered for no movement.
After 115% of the time in open mode, return must be Open	Otherwise a return alarm is triggered for open mode.
The unit confirms OK and starts.	

11.2. Fire/smoke detector

Start page > Main menu > Configuration > Configuration 1 > Fire alarm

Parameter	Function
No	No fire alarm.
Alarm	External fire alarm such as smoke detectors, thermostat, fire alarm control centre, etc.
Temp	Internal fire alarm via measurement of normal supply air and extract air temperature when both sensors are accessible. A fire alarm is triggered when one of the two temperatures reaches a specific value.
Alarm+Temp	Both fire alarms.

After making a change in a configuration menu, a restart is required.

Start page > Main menu > Configuration > Configuration 1 > Restart > Execute



For selection of Temp or Alarm+Temp, the alarm limits for the temperatures are configured as follows:

Start page > Quick menu > Setpoints/Settings > All settings > Alarm limits

Parameter	Function
Supply air temp. fire limit	Alarm limit for high supply air temperature.
Extract air temp. fire limit	Alarm limit for high extract air temperature.

For selection of Alarm or Alarm+Temp, the fan regulation is configured as follows:

Start page > Main menu > Unit > Fan control > Fire function

Parameter	Function
Stop	The fans stop in the event of fire.
SF operation	The supply air fan operates on the set max. step. The extract air fan stops.
EF operation	The extract air fan operates on the set max. step. The supply air fan stops.
Operation	Both fans operate on the set max. step.

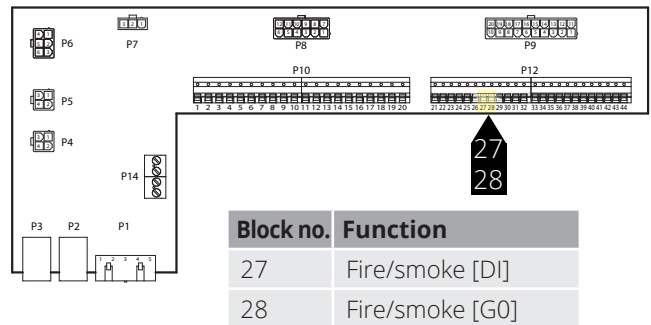

The input is normally open (NO) and produces an alarm if it closes. This can be reconfigured to normally closed (NC) via:

Start page > Main menu > Unit > Inputs > Fire > Contact function

Parameter	Function
NO	Normally open = produces an alarm if the input closes.
NC	Normally closed = produces an alarm if the input opens.

11.3. Air quality

Fans (see Fan compensation) are regulated based on air quality. The outdoor air volume increases when the carbon dioxide content exceeds a certain value (the fan speed increases and the circulation volume decreases). The outdoor air volume decreases when the carbon monoxide content exceeds a set value (the fan speed decreases and the circulation volume increases).

Start page > Main menu > Configuration > Configuration 2 > Fan comp. air quality = Yes

After making a change in a configuration menu, a restart is required.

Start page > Main menu > Configuration > Configuration 1 > Restart > Execute



Start page > Main menu > Unit > Air quality regulation

Parameter	Value	Function
Regulator	0...100 [%]	Current regulator value. Go to the page for regulator settings
Function	The output signal must be selected based on current requirements:	
	Normal	Normal for CO ₂
	Inverted	Inverted for carbon monoxide.
Setpoint	0...3000 [ppm]	Setpoint for air quality regulation.

Scaling of the CO₂ sensor

Start page > Main menu > Configuration > Config. Inputs/Outputs > Other > Air quality sensor

Parameter	Function
X8	This is the physical input for the regulator and must not be changed.
2000 ppm	This is the upper limit for the CO ₂ sensor. With 10 V in the output

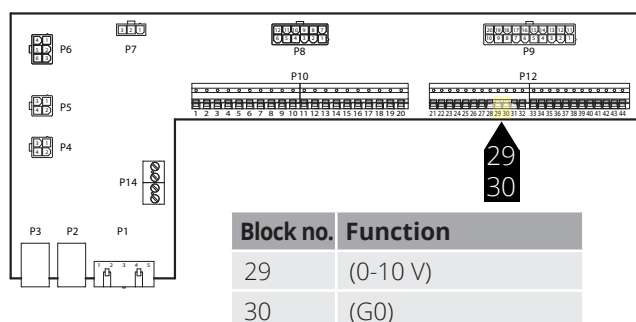

> EXAMPLE OF CO₂ REGULATION

The setpoint is set to 800 ppm and the CO₂ sensor detects an actual value of 1,000 ppm. The unit switches up to speed 3 and remains at this speed until the CO₂ sensor detects an actual value below 800 ppm, at which time the unit switches down to the speed set in the current time channel.

11.4. AUX Damper

The output signal is affected by the speed of the ventilation unit. The function can be used, for example, to open a damper when the unit switches to a higher speed. The function must be activated in the control system. This is done via the following menu option.

Start page > Main menu > Configuration > Configuration 2

Parameter	Value	Function
Aux. output signal	No	Analogue aux. output that generates a 0-10 V signal, depending on current fan step.
	Fan	An output signal can be set for each fan step. For example 10% at step 1 and 60% at step 2.
	Flow device	The output signal here depends on the difference between the supply air temperature and the room temperature. Adjustable to the difference that produces 0 V and 10 V. For example supply air temperature-room temperature = 5 degrees produces a 7 V output signal.

After making a change in a configuration menu, a restart is required.

Start page > Main menu > Configuration > Configuration 2 > Restart



Start page > Main menu > Unit > Auxiliary

Parameter	Value	Function
Fan step 0	0...100 [%]	Aux. output signal when unit is off (also for system error).
Fan step 1	0...100 [%]	Aux. output signal with active fan step 1 (setpoint 1 for regulated fans).
Fan step 2	0...100 [%]	Aux. output signal with active fan step 2 (setpoint 2 for regulated fans).
Fan step 3	0...100 [%]	Aux. output signal with active fan step 3 (setpoint 3 for regulated fans).

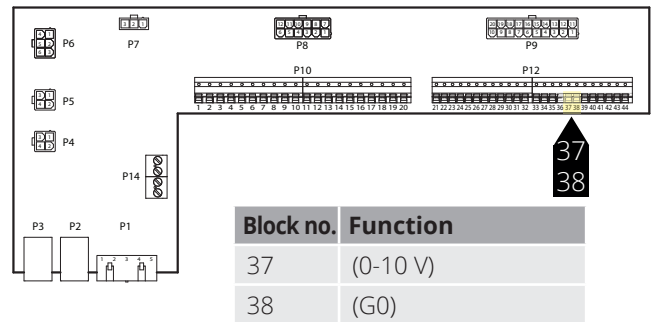

12. Web

The unit can be controlled via the web. This is done by the control panel being mirrored in a web browser. If you want to have flow charts showing the current values for temperatures, flows, etc., a web module (accessory) must be installed.

To configure the function, go to the following menu:

Start page > Main menu > System overview > Communication > TCP/IP > DHCP

Parameter	Function
Active	The regulator is assigned an IP address from the network
Passive	A fixed IP address is set in the regulator

Information on other settings under the communication menu is available from the staff in charge of the network.

After making a change, a restart is required.

Start page > Main menu > System overview > Communication > TCP/IP > Restart



After restart, go to:

Start page > Main menu > System overview > Communication > TCP/IP

and make a note of the **Current IP**.

Then go to **Other settings** further down the same menu. Make a note of the **User name** and **Password**.

Then open your web browser, go to the IP address you noted down and log in with the **User name** and **Password** you noted down.

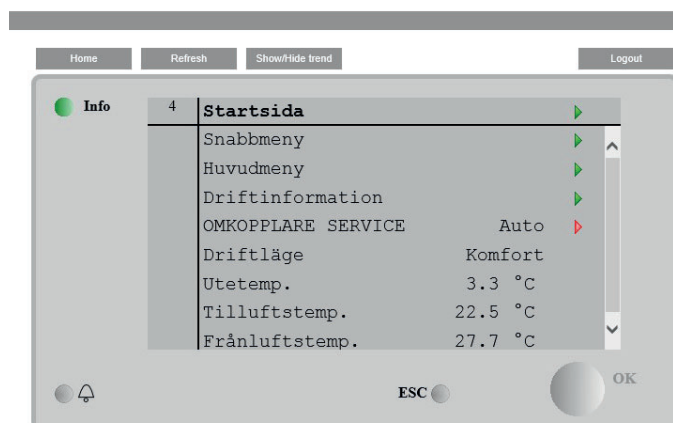

Flexit AS | Corporate Information | Privacy Policy | Terms of use | Digital ID

You can now navigate using the arrow keys and ESC to go in and out of menus.

13. ModBus TCP/IP

The unit can be controlled via ModBus TCP/IP as a default function in the regulator. If you want to have ModBus with RS485 serial communication, a communication module (accessory) must be installed.

To configure the function, go to the following menu:

Start page > Main menu > System overview > Communication > Modbus > TCP/IP > DHCP

Parameter	Function
Active	The regulator is assigned an IP address from the network
Passive	A fixed IP address is set in the regulator

Information on other settings under the communication menu is available from the staff in charge of the network.

After making a change, a restart is required.

Start page > Main menu > System overview > Communication > Modbus > Restart

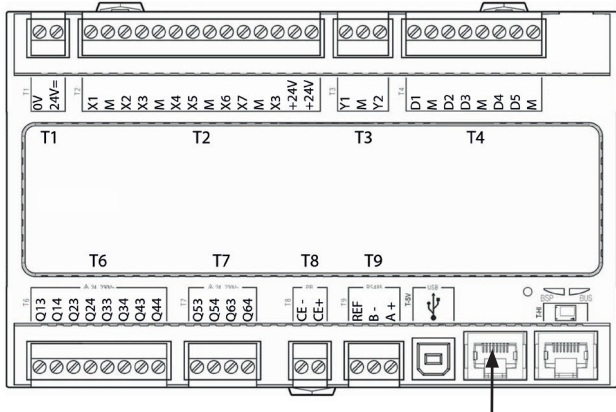

Connect here.

The parameter list for ModBus can be downloaded at www.flexit.com.

14. DX heating/cooling

This function is only available on software V3.07 and later. To see the current version for the unit:

Main menu > System overview > Versions > Flexit AHU

If the function is needed on older versions, contact Flexit.

The control system is able to control a heat pump for heating and cooling, which is connected to ducted coils. It can be used both as a free-standing unit or in sequence ahead of the internal electric-powered coils, which can then be used as peak heating and/or as reserve heating while the heat pump is defrosting.

For the function to operate, I/O module SP90 must be installed and configured. See Manual 112548.

If you wish to use the internal electric-powered coils, these must be installed/configured as shown in the manual supplied with the coils.

14.1. Configuration of control system

Start page > Main menu > Configuration > Configuration 1 > Additional heating

Parameter	Function
No	Additional heating deactivated
Yes	Additional heating activated
Yes+Preh+Outd.	Additional heating with preheating based on outdoor air temperature. Analogue heating valve output.
Yes+Preh.Frost protection temp.	Additional heating with preheating based on frost protection temperature.

Select **Yes** to activate the function.

Start page > Main menu > Configuration > Configuration 1 > Additional cooling

Parameter	Function
No	Additional cooling deactivated
Water	Additional cooling via 0-10V signal
DX 1step	Additional cooling Off/On 1 step
DX 2step	Additional cooling Off/On 2 step
DX 3step	Additional cooling Off/On 3 step

Select **Water** to activate the 0-10V output signal for the function. After making a change in a configuration menu, RESTART.



The unit will show an alarm on startup. This can be removed by the configuration shown further down.

Start page > Main menu > Configuration > Configuration 2 > Pump, additional heating

Parameter	Function
No	No Off/On signal to pump
Yes	Off/On signal to pump
Yes+Exercise	No Off/On signal to pump + exercise operation

Start page > Main menu > Configuration > Configuration 2 > Cooling 2 pump

Parameter	Function
No	No Off/On signal to pump
Yes	Off/On signal to pump
Yes+Exercise	Off/On signal to pump +exercise motion

Select **Yes** on both heating and cooling. Used to signal a heating/cooling requirement to the heating pump.

Start page > Main menu > Configuration > Configuration 2 > Heat pump defrosting

Parameter	Function
No	Defrosting function deactivated
Yes	Defrosting function activated

Select **Yes**. Used to lock the output signal to the heat pump and if necessary activate electric heating (if connected) when defrosting the heat pump.

Start page > Main menu > Configuration > Configuration 2 > Additional heating regulation

Parameter	Function
Standalone	Regulation seeks its own temperature target value
Sequence Heating-Additional heating	Regulation uses the sequence electrical heating - heat pump
Sequence Additional heating-Heating	Regulation uses the sequence heat pump - electrical heating

Select **Sequence Additional heating - Heating** to force the regulation to operate using the sequence Heat pump first and electrical heating second.

Start page > Main menu > Configuration > Configuration 2 > Additional cooling regulation

Parameter	Function
Standalone	Regulation seeks its own temperature target value
Sequence	Regulation uses the sequence before or after ordinary cooling regulation

Select **Sequence** to force the regulation to operate in sequence with heat recovery and heating.

Start page > Main menu > Configuration > Configuration 2 > E.g. Combi Coil

Parameter	Function
No	Function deactivated
1output	Function activated shared output
2outputs	Function activated two different outputs

Select **1output** to send the same signal (0-10V) to the heat pump for both heating and cooling.

After making a change in a configuration menu, **RESTART**.



After restarting, an alarm will appear on the regulator requiring configuration of which input is connected to the heat pump defrosting function.

Start page > Main menu > Configuration > Config. In/Outputs > Digital inputs > Heat pump defrosting

Parameter	Function
D4	Block P12-35

Select **D4**. This will connect block P12-35 on the A2 circuit board to the function. The input is also used for resetting the fire damper. If both functions are used, contact Support to configure a new input.

For the output that alternates between heating and cooling to work, the pump output must be configured differently.

Start page > Main menu > Unit > Outputs > Heating 2 pump cmd > Contact function > NO/NC

Set this to NO.

Start page > Main menu > Unit > Outputs > Cooling 2 pump cmd > Contact function > NO/NC

Set this to NC.

Parameter	Function
NO	Closes the contact when heat is required
NC	Opens the contact when heat is required

Parameter	Function
NO	Closes the contact when cooling is required
NC	Opens the contact when cooling is required

 **NB** Remember that if both pump additional heating and pump additional cooling have been configured, they will actuate the same physical output and will both be set to NO as default.

14.2. Installation

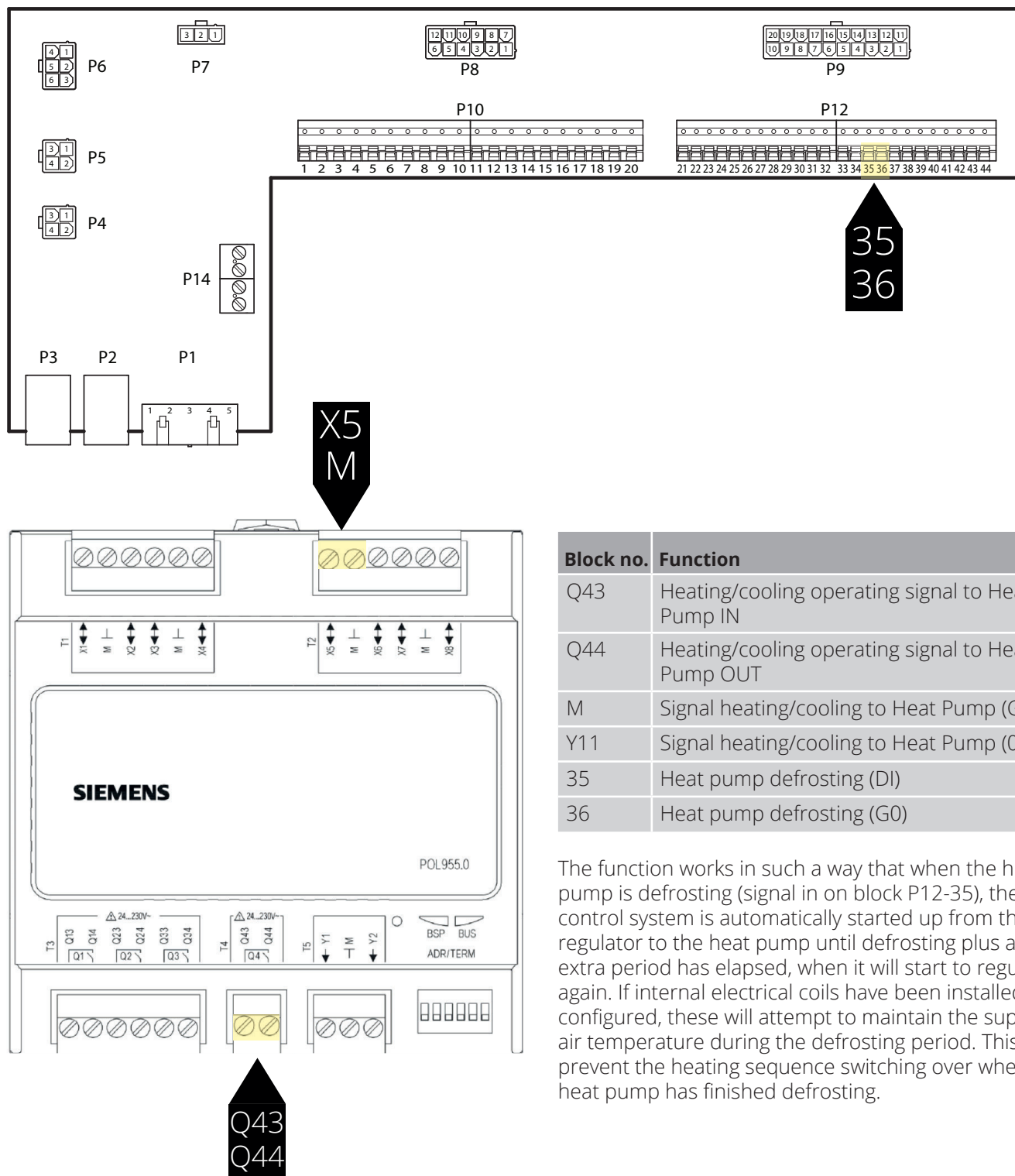

To adjust the function's locking time:

Start page > Main menu > Unit > Temperature regulation > Additional heating > Heat pump defrost. Lock electrics

The standard setting is 60 seconds.



NB There is a limit on both time and outdoor temperature for the automatic switching between summer (cold) and winter (heat) mode.

See menu below to test the function. Here the time constant can be lowered and the unit can be changed to summer or winter operation by entering a fixed date or changing the temperature limits.

Main index > Global functions > Su/Wi Calculation



NB This function will not work if extract air regulation is chosen.

Check here that extract air regulation has not been chosen.

If extract air regulation has been chosen, we recommend changing it to extract air cascade regulation (Extract air cascade).

Start page > Main menu > Configuration > Configuration 1 > Temperature regulation type



Flexit AS, Televeien 15, NO-1870 Ørje www.flexit.no